

蘇我三丁目

(世界測地系)

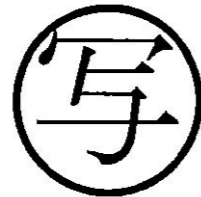
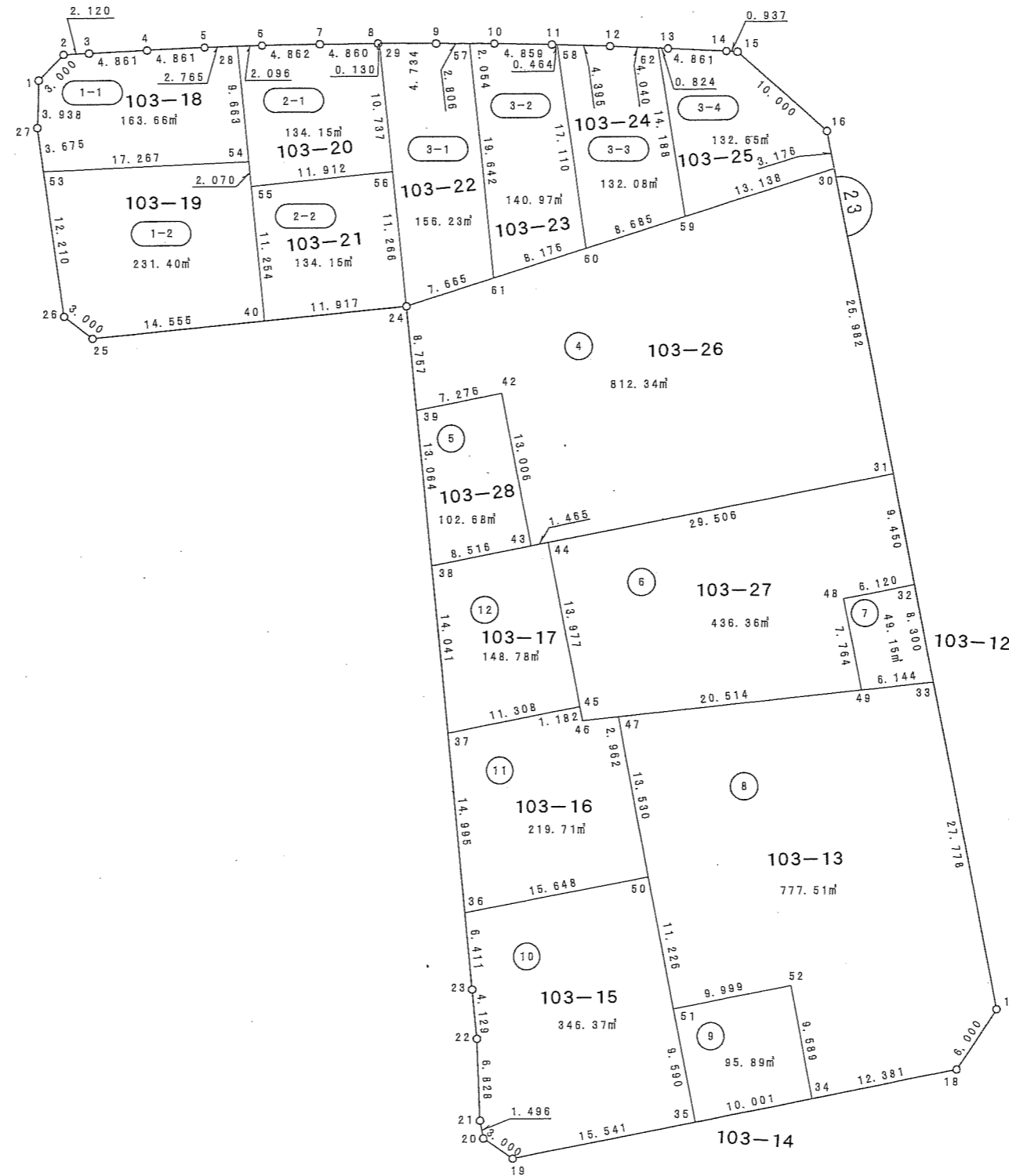
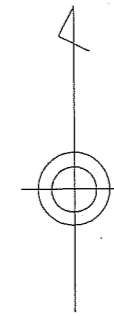

縮尺 1:500

蘇我三丁目

(世界測地系)

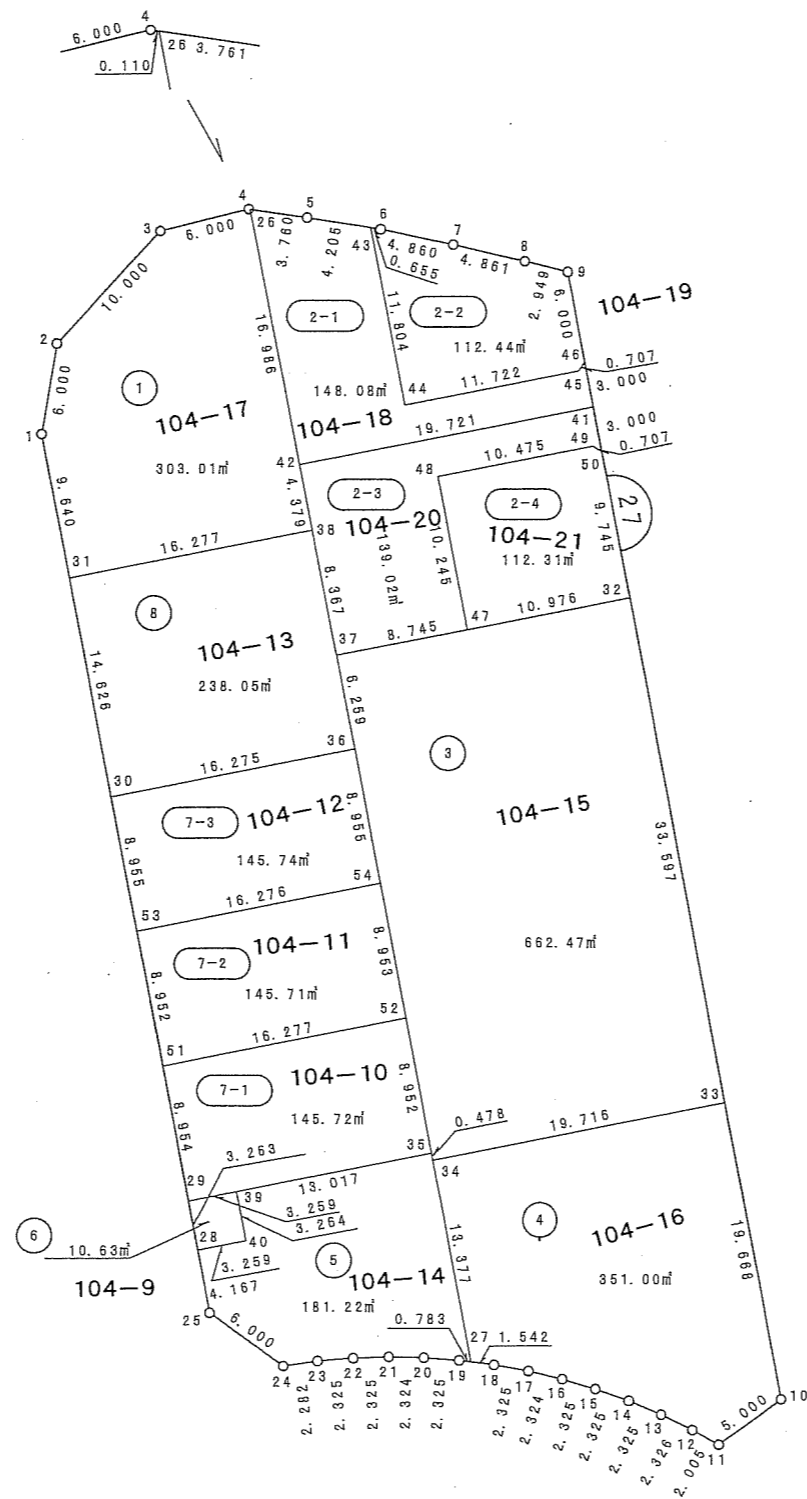
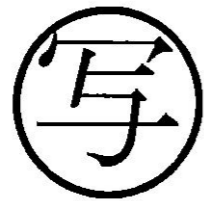

縮尺 1:500

蘇我三丁目

(世界測地系)

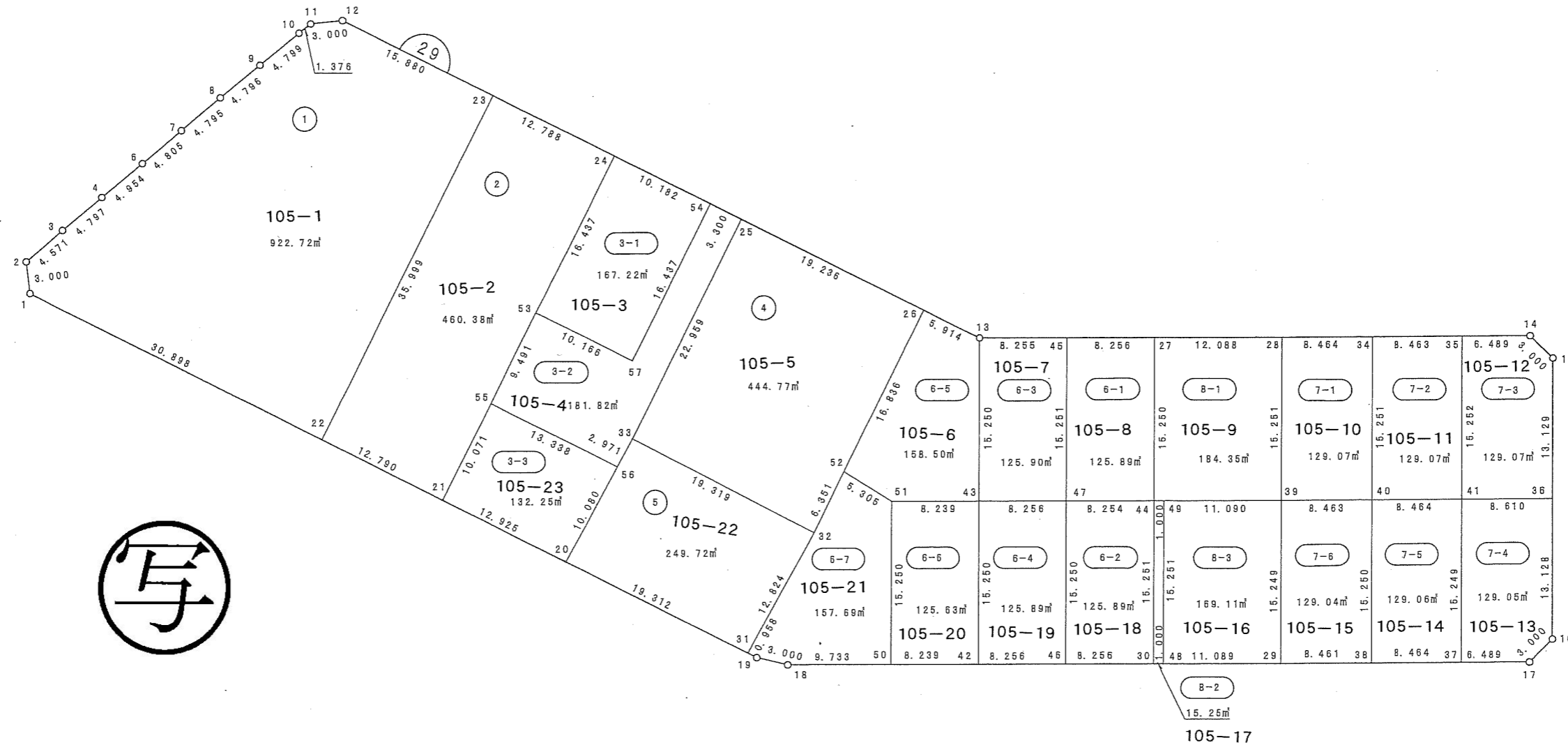
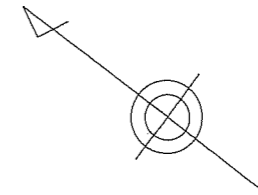

縮尺 1:500

蘇我三丁目

(世界測地系)

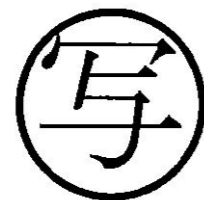
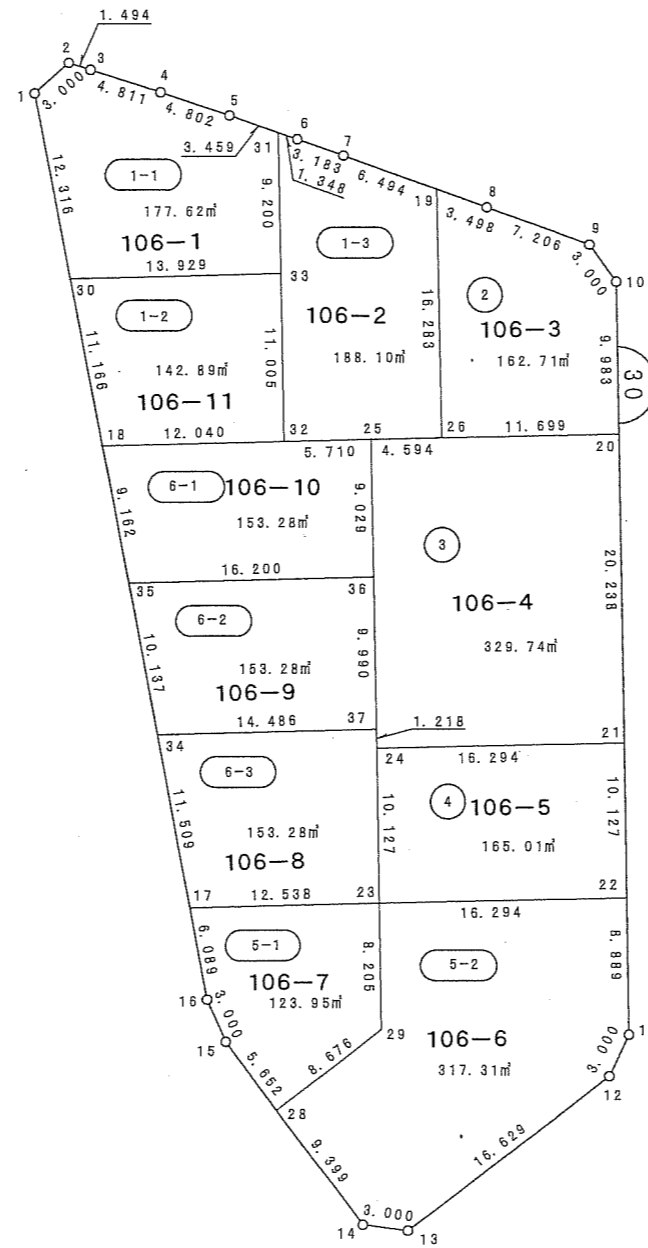
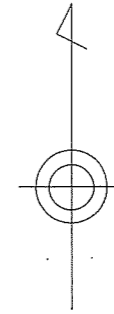

縮尺 1 : 500

蘇我三丁目

(世界測地系)

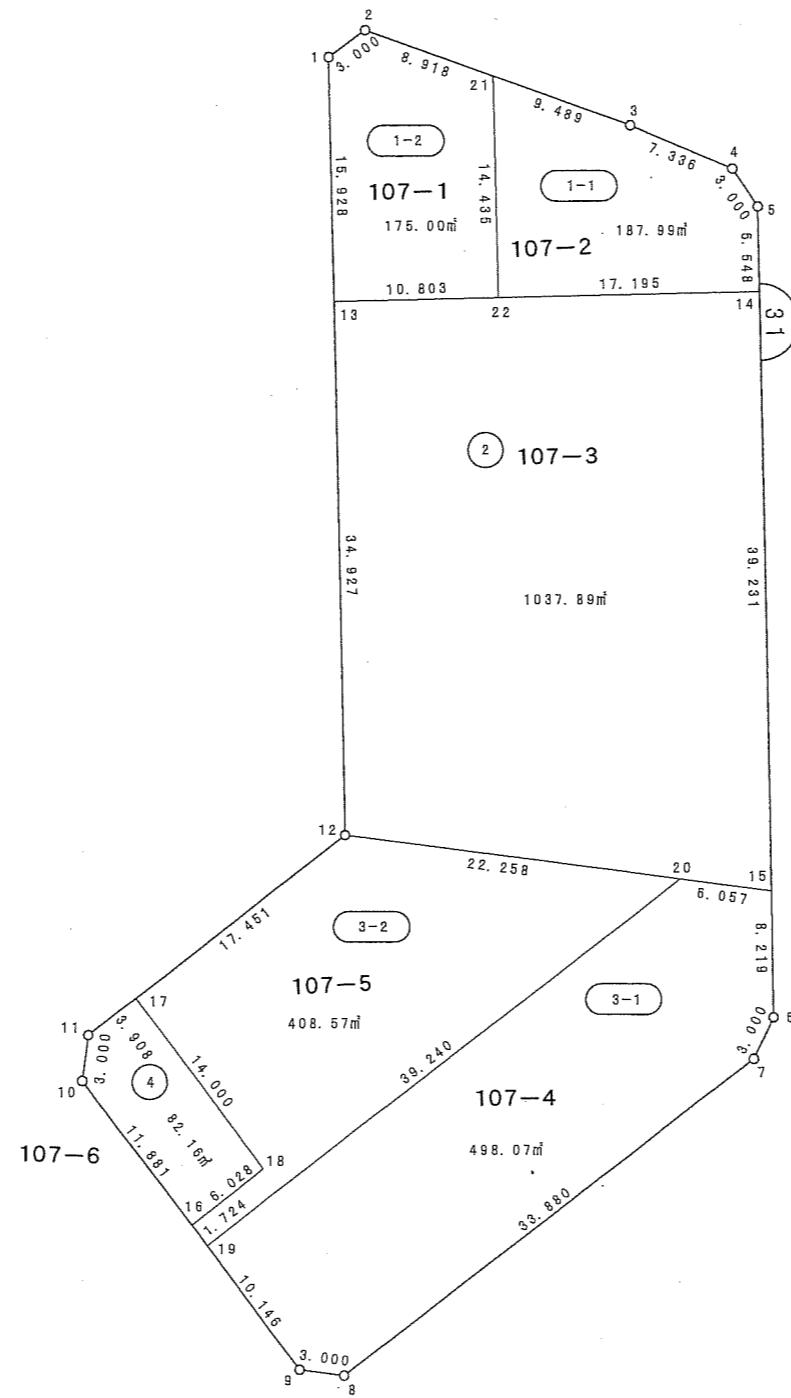
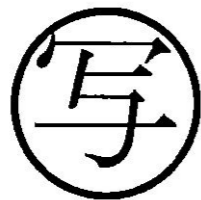
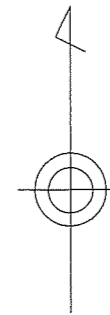

縮尺 1 : 500

蘇我三丁目

(世界測地系)

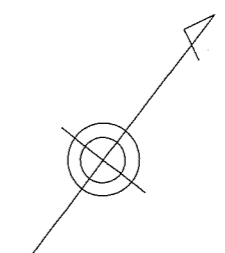
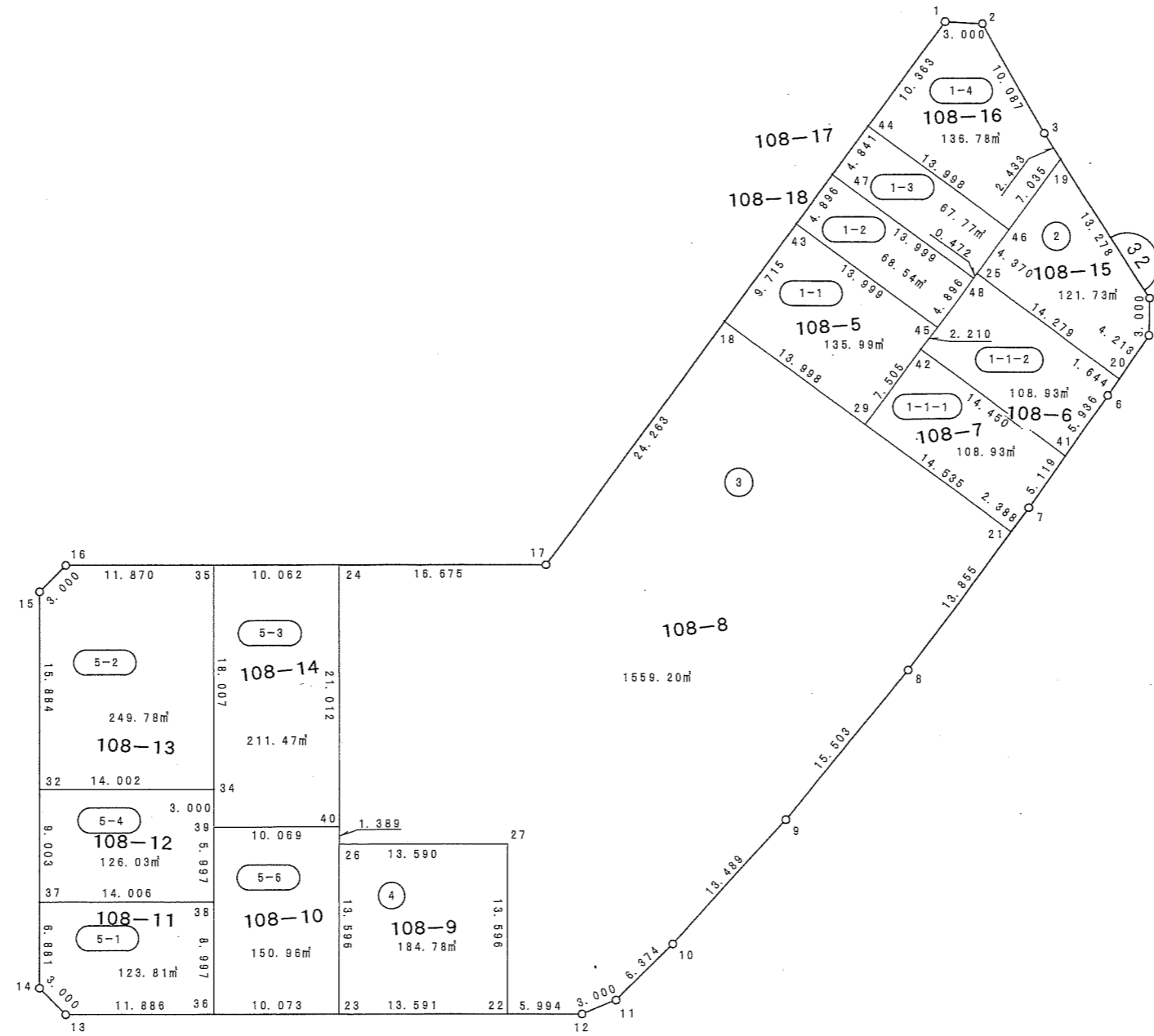
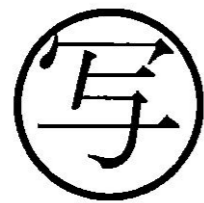

縮尺 1 : 500

蘇我三丁目

(世界測地系)

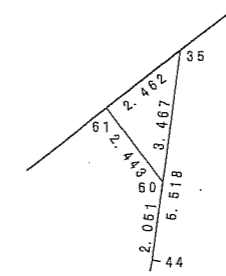
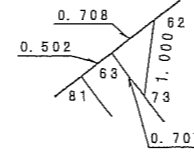
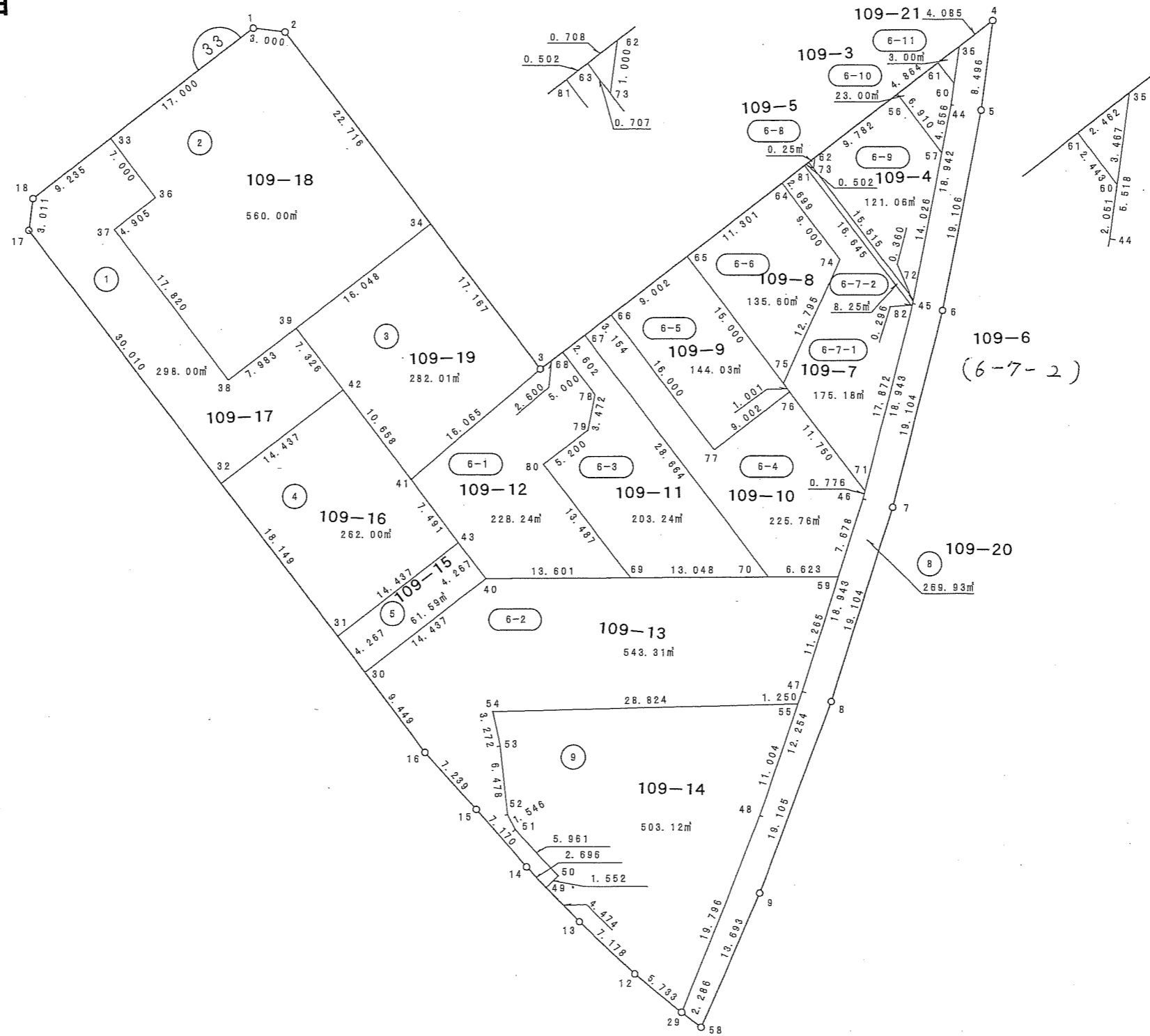
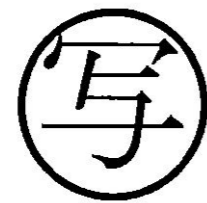
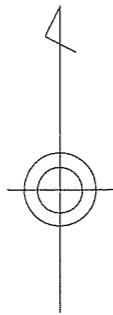

縮尺 1 : 500

蘇我三丁目

(世界測地系)

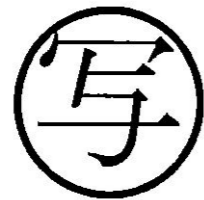
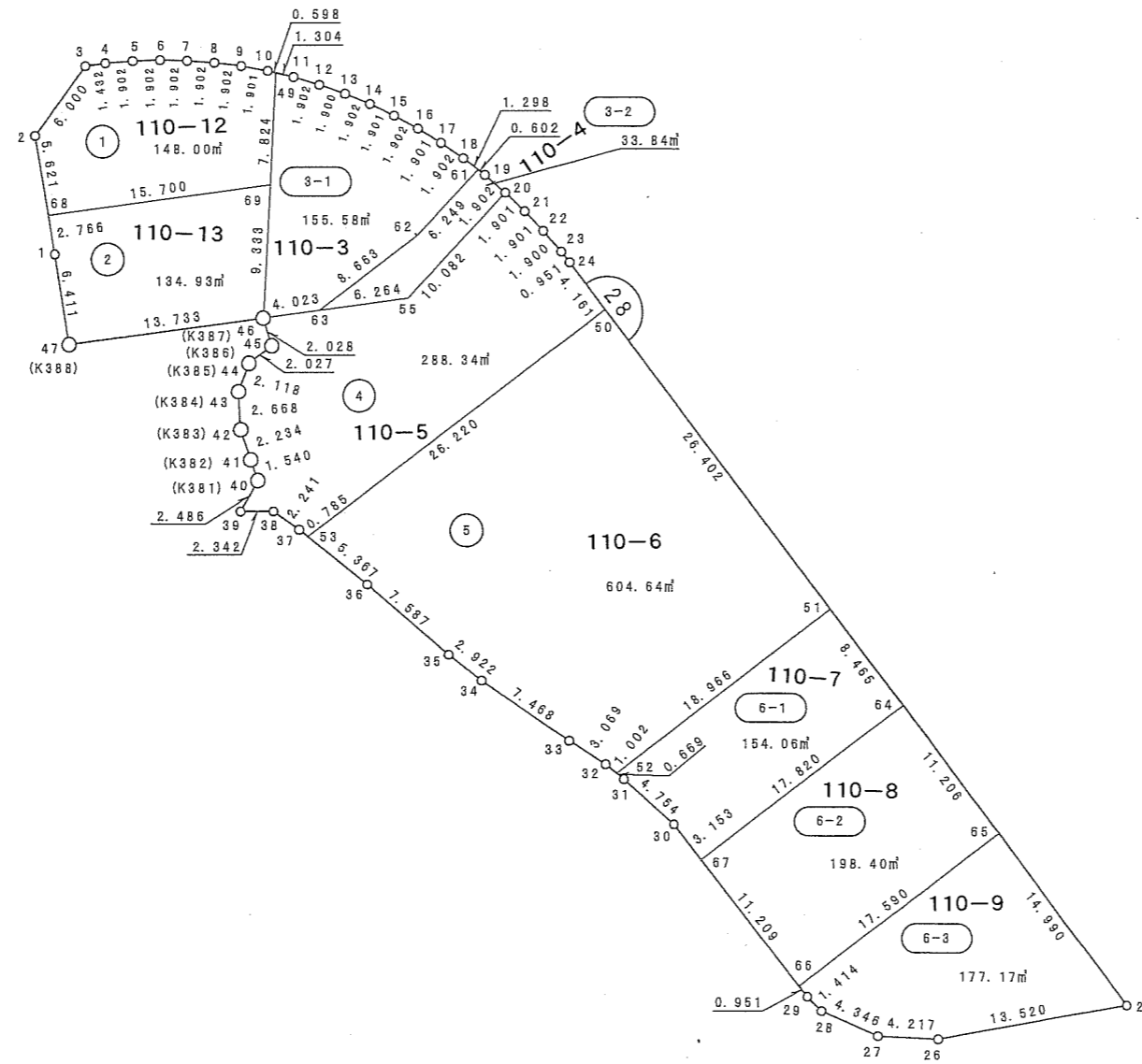
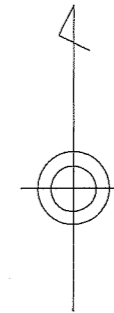

縮尺 1 : 500

蘇我三丁目

(世界測地系)

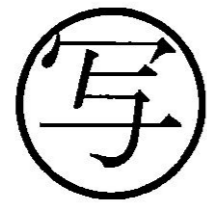
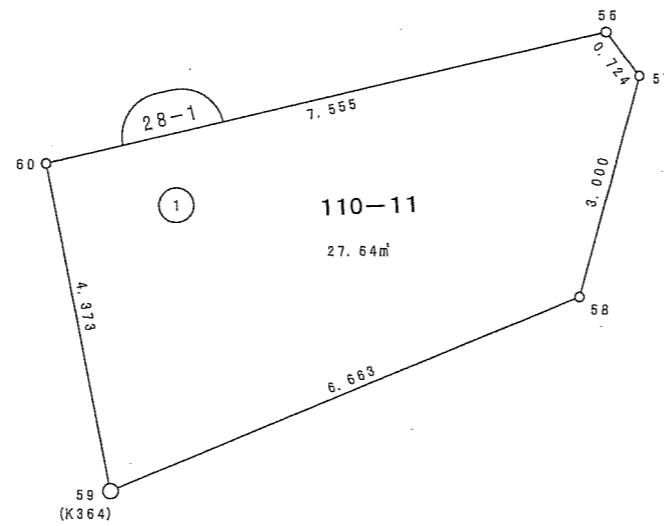
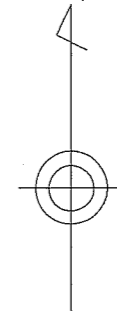

縮尺 1 : 100

蘇我三丁目

(世界測地系)

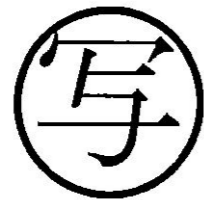
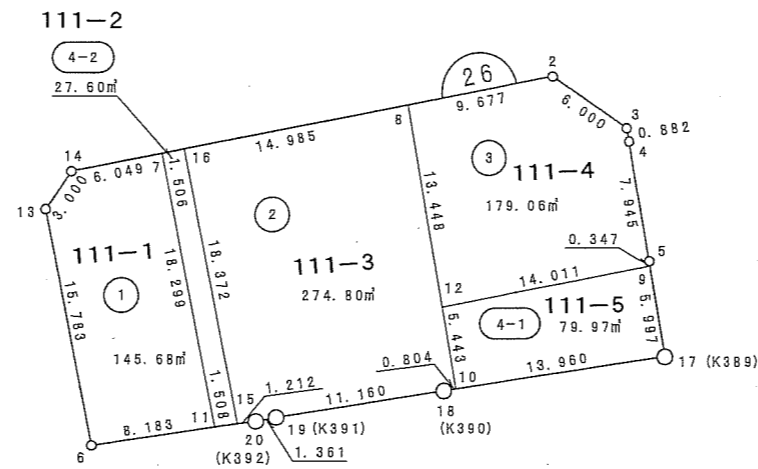
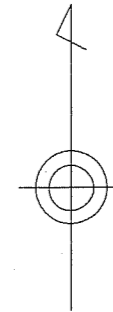

縮尺 1:500

蘇我三丁目

(世界測地系)

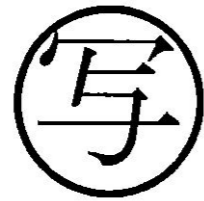
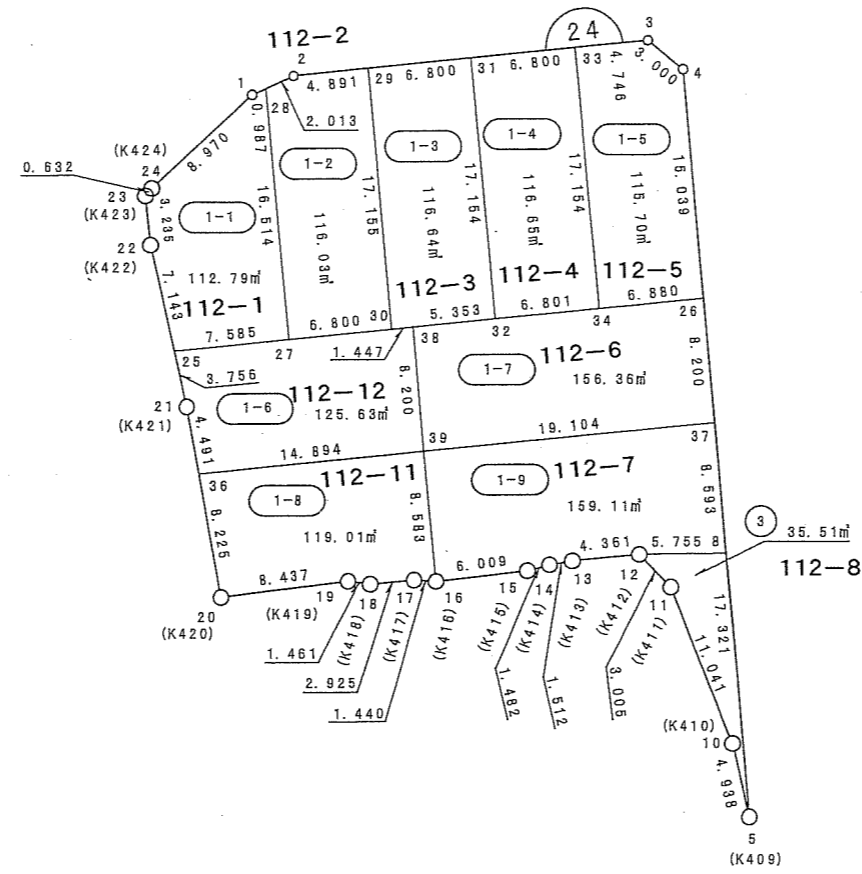
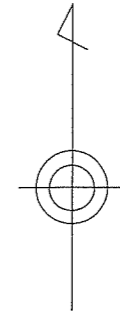

縮尺 1 : 500

蘇我三丁目

(世界測地系)

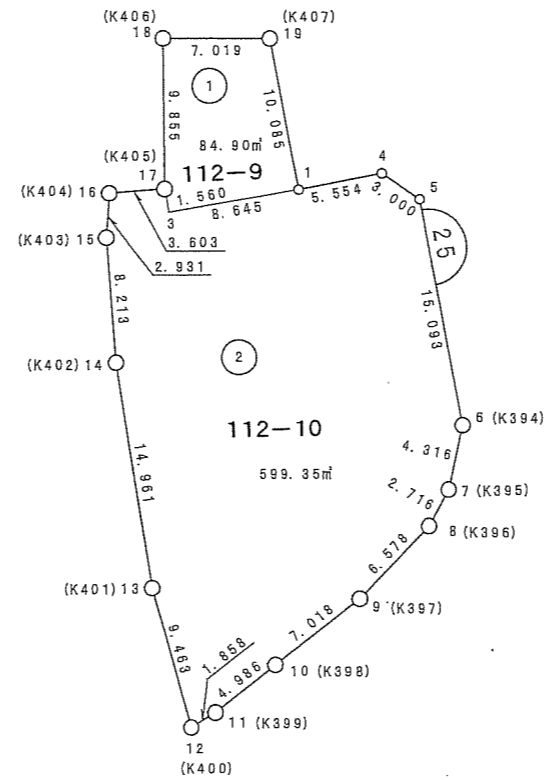
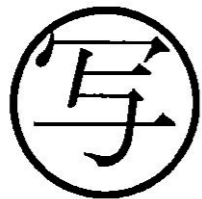
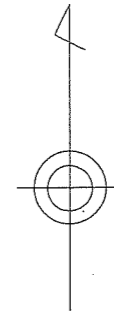

縮尺 1 : 500

蘇我三丁目

(世界測地系)

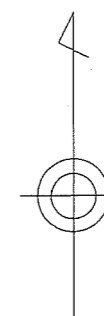

写

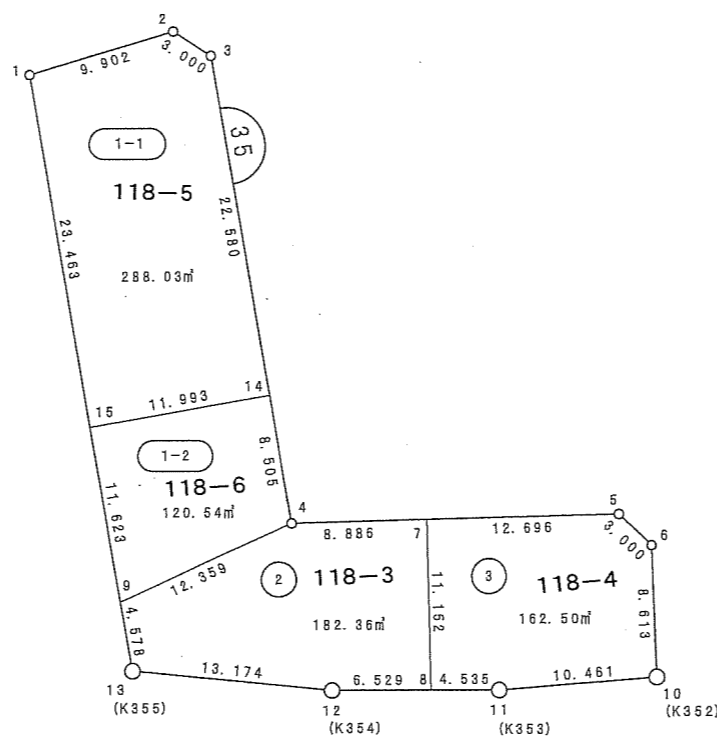

縮尺 1 : 500

蘇我三丁目

(世界測地系)

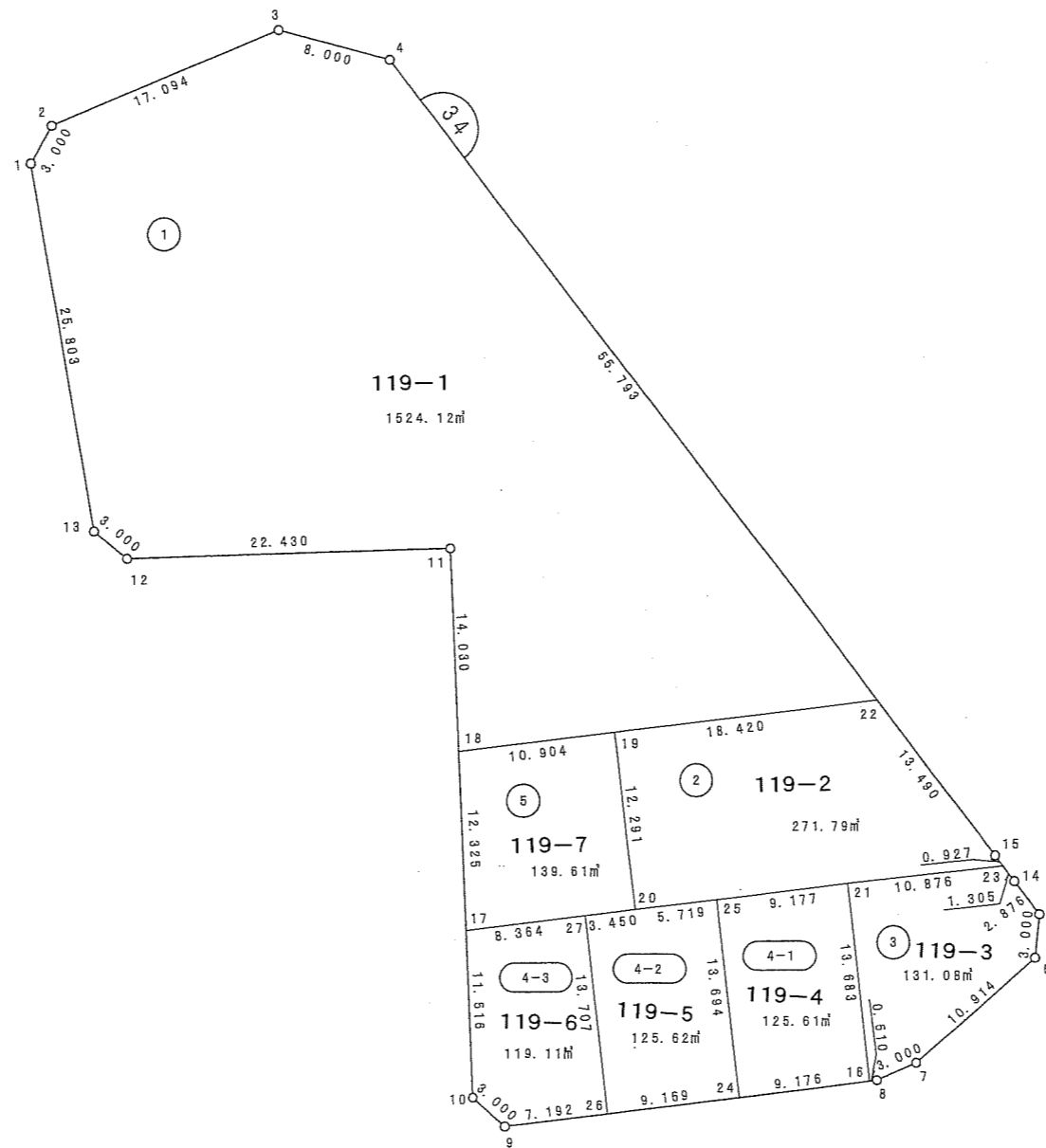
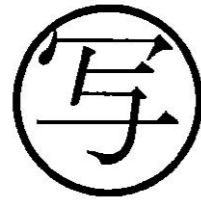
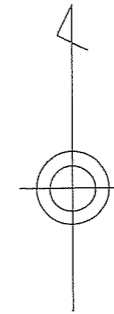

縮尺 1 : 500

蘇我三丁目

(世界測地系)

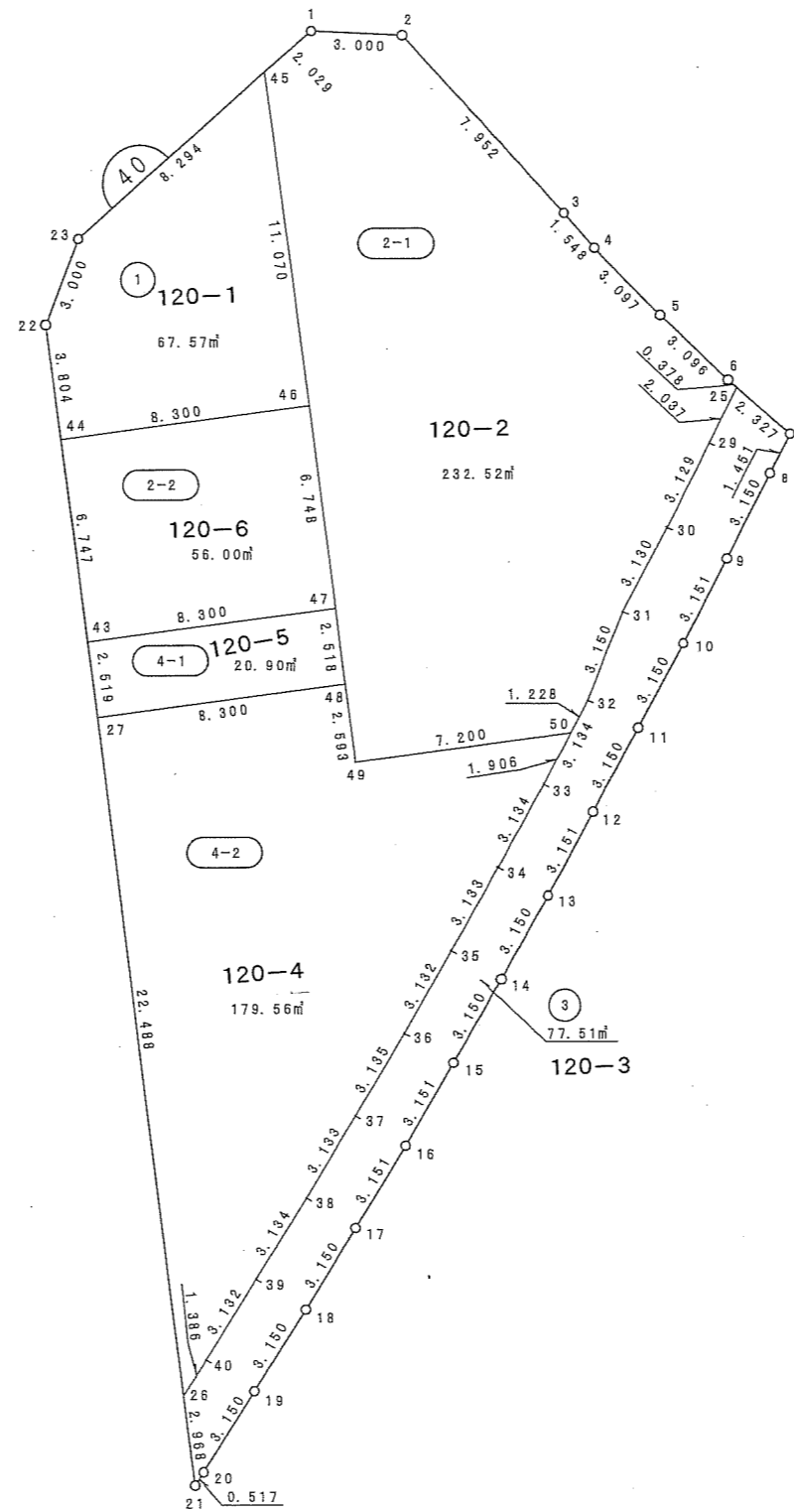
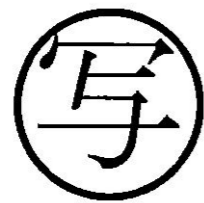
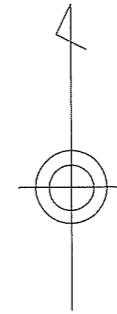

縮尺 1 : 250

蘇我三丁目

(世界測地系)

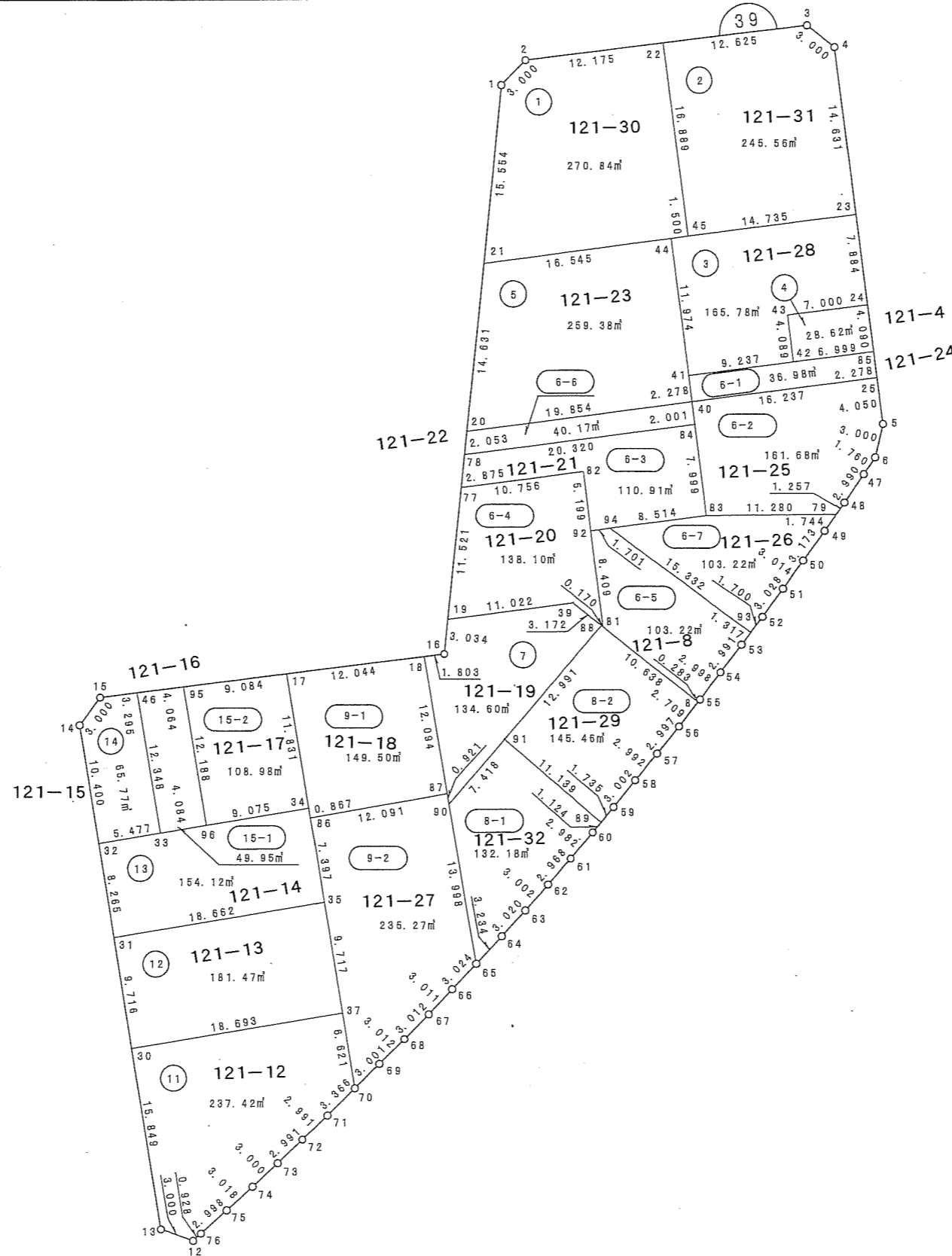
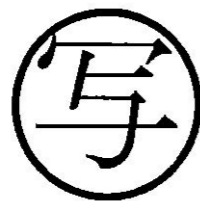
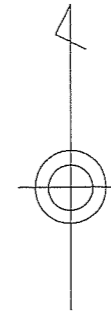

縮尺 1:500

蘇我三丁目

(世界測地系)

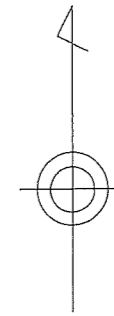

写

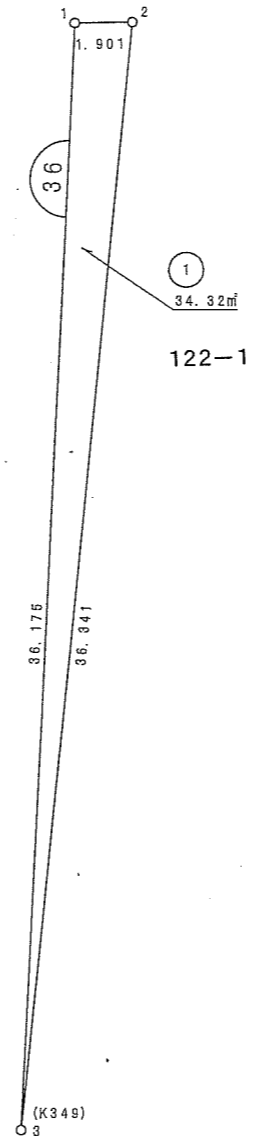

縮尺 1 : 500

蘇我三丁目

(世界測地系)

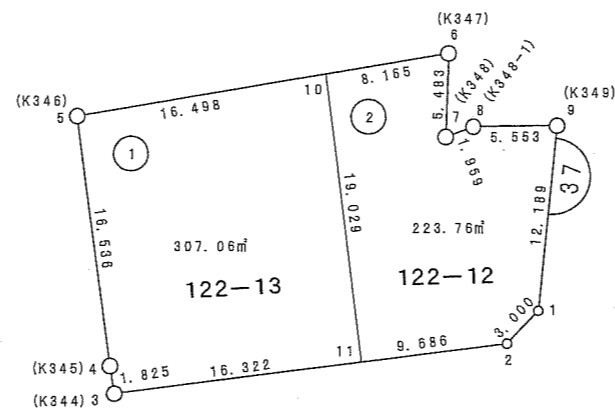
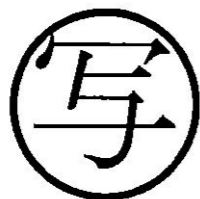
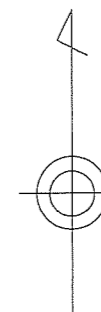

縮尺 1 : 500

(世界測地系)

蘇我三丁目

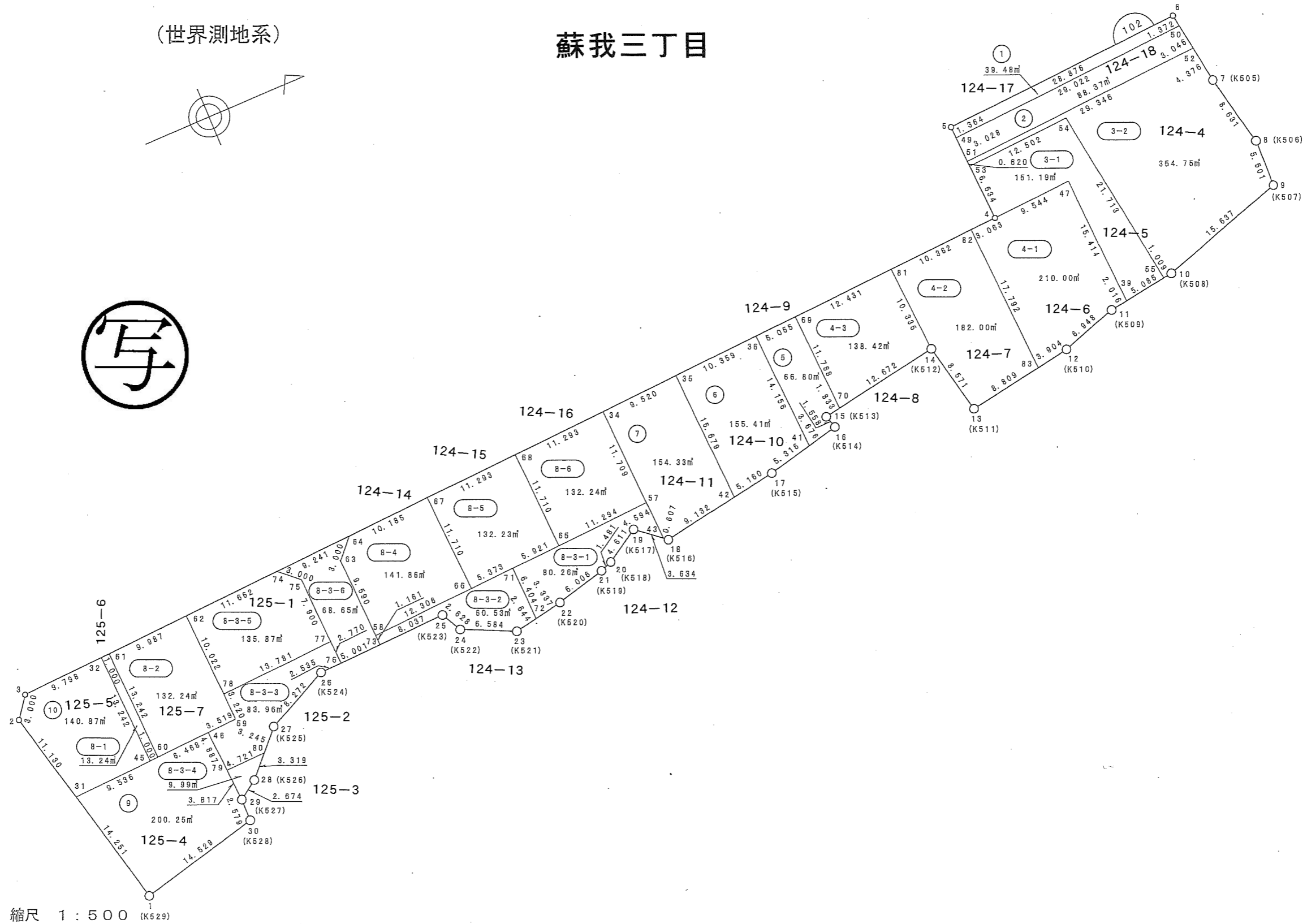
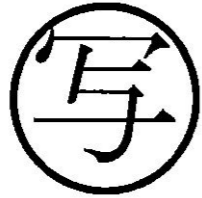
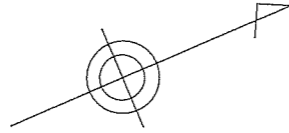

縮尺 1 : 500 (K529)

(世界測地系)

蘇我三丁目

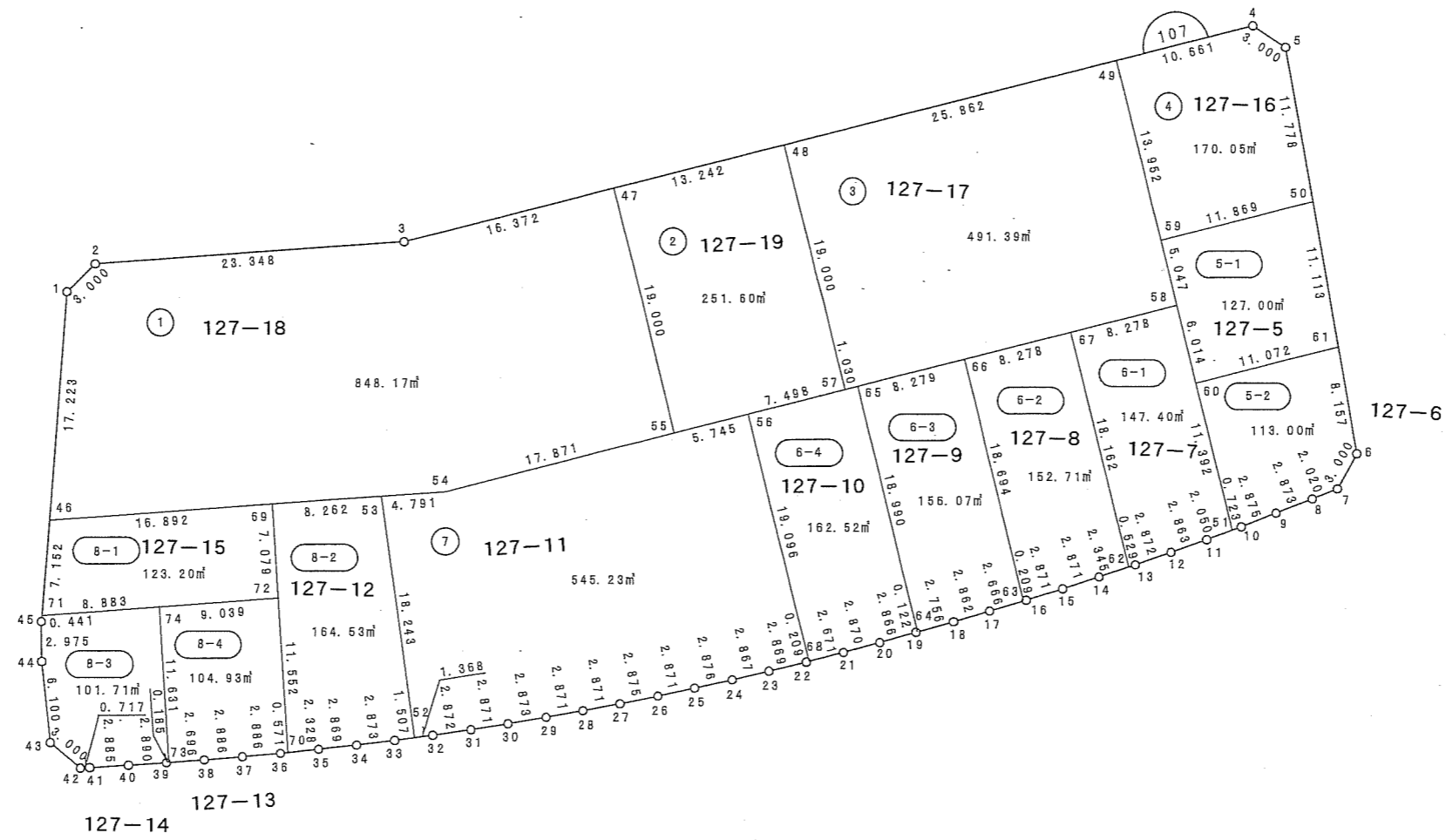
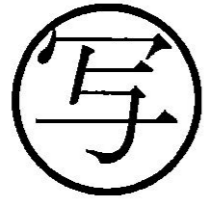

縮尺 1:500

株式会社
日測

(世界測地系)

蘇我三丁目

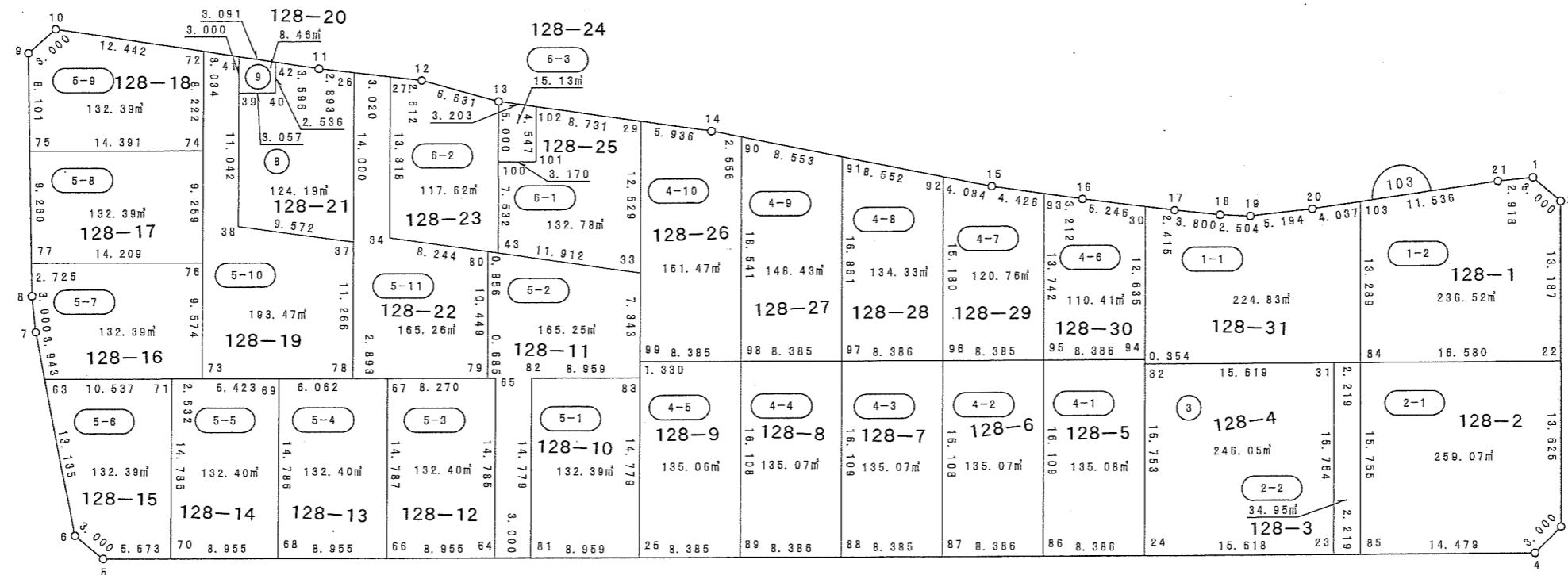
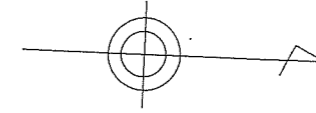

縮尺 1 : 500

蘇我三丁目

(世界測地系)

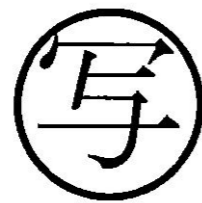
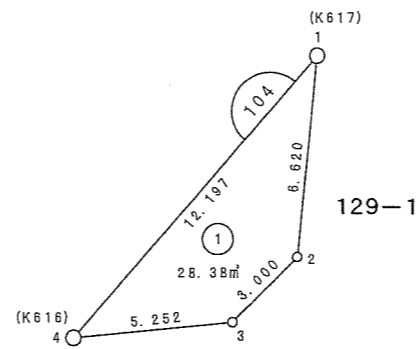
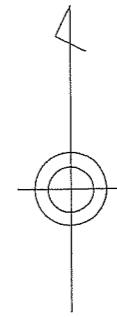

縮尺 1 : 250

(世界測地系)

蘇我三丁目

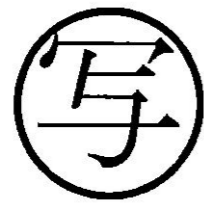
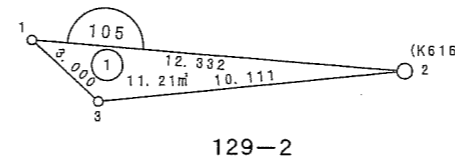
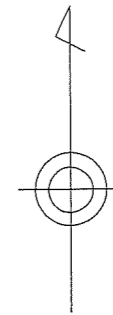

縮尺 1 : 250

蘇我三丁目

(世界測地系)

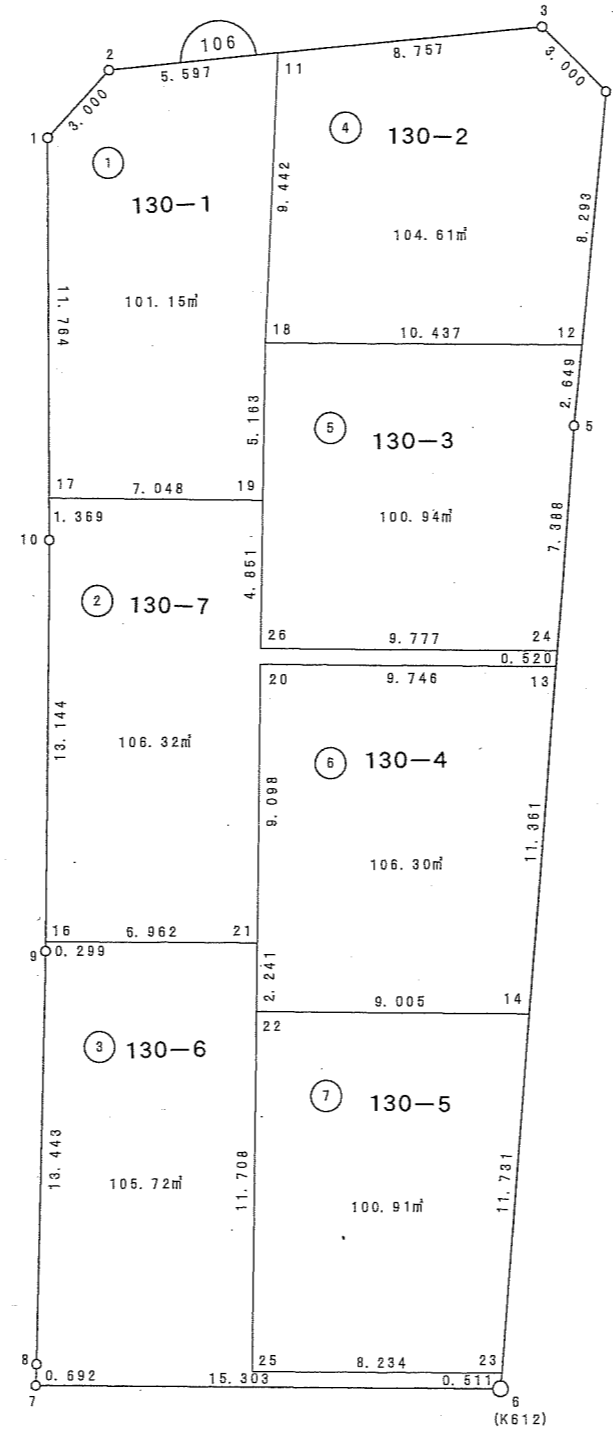
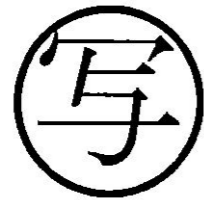
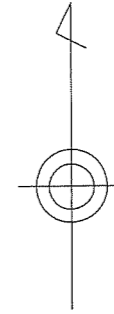

縮尺 1 : 250

(世界測地系)

蘇我三丁目

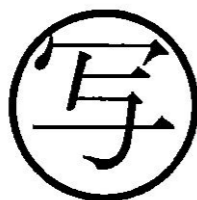
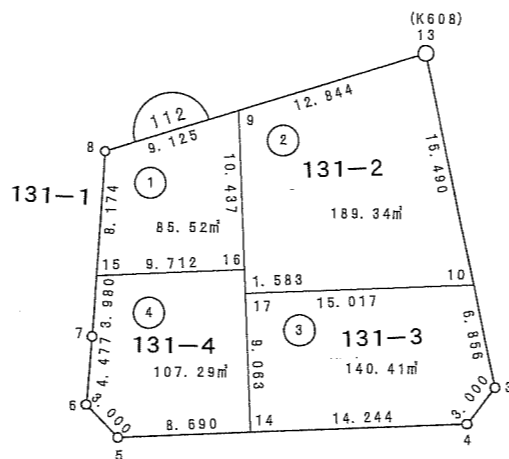
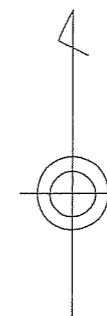

縮尺 1:500

(世界測地系)

蘇我三丁目

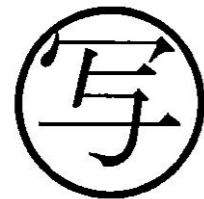
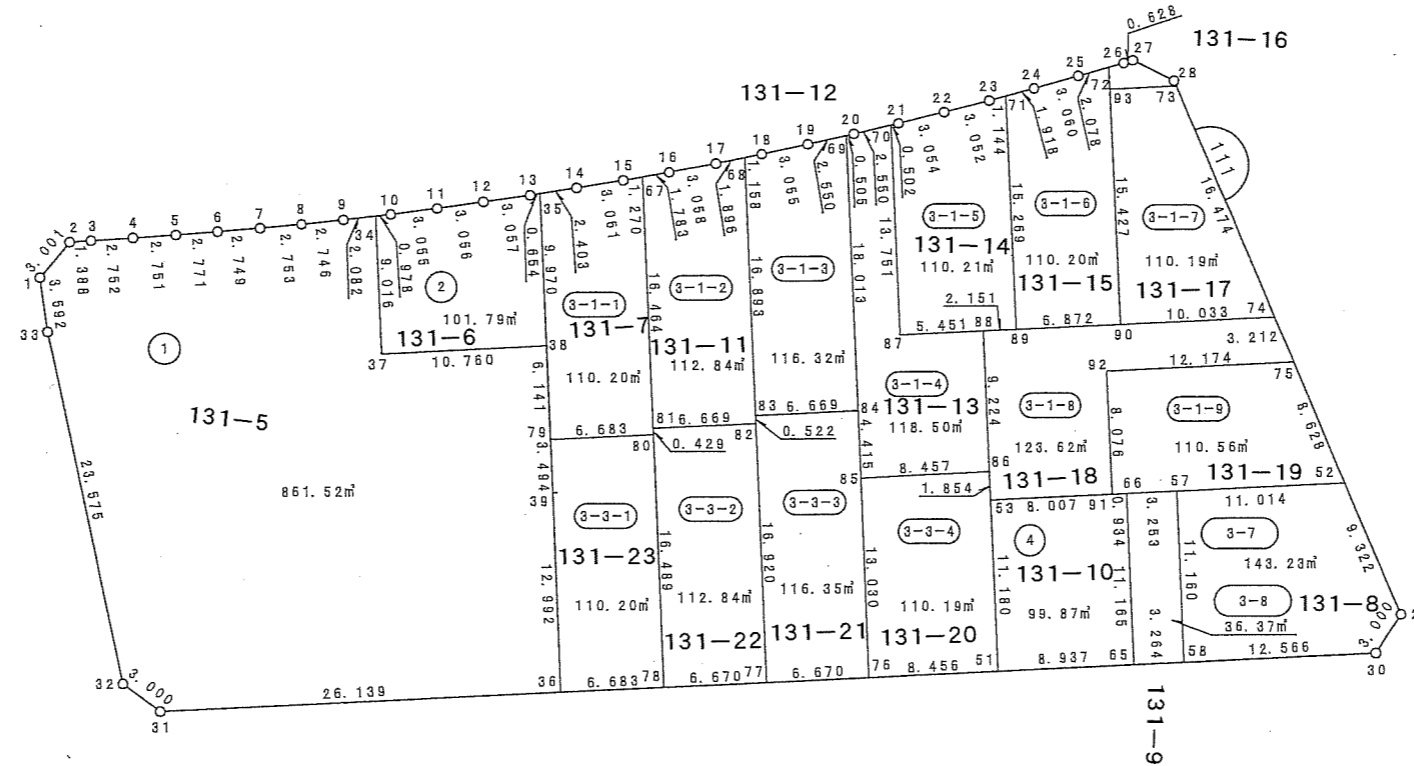
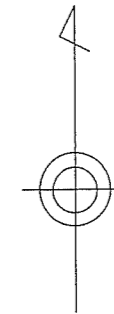
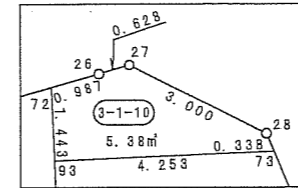

縮尺 1:500

(世界測地系)

蘇我三丁目

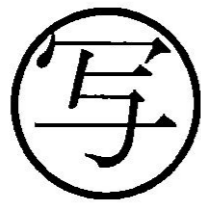
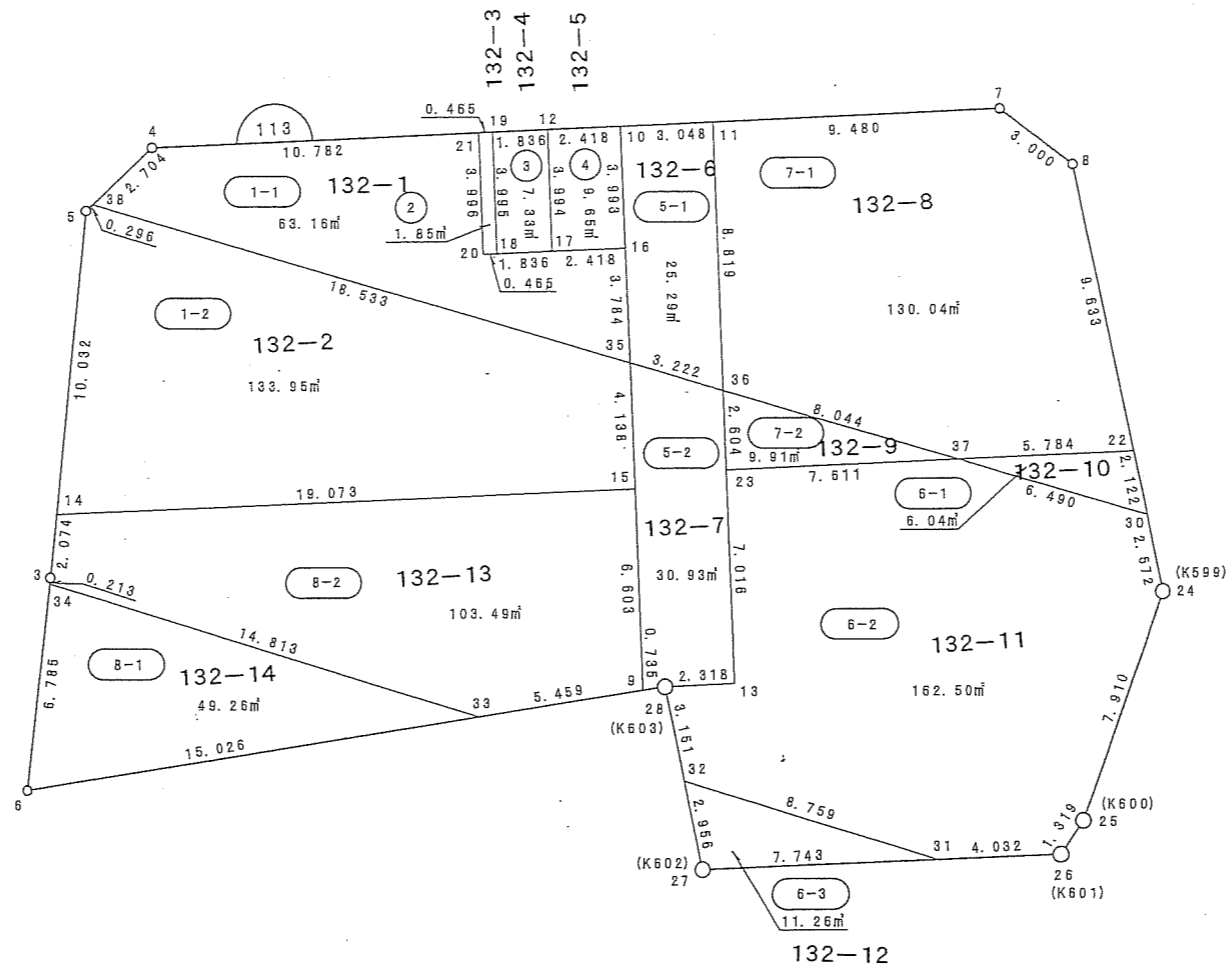
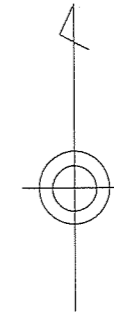

縮尺 1 : 250

(世界測地系)

蘇我三丁目

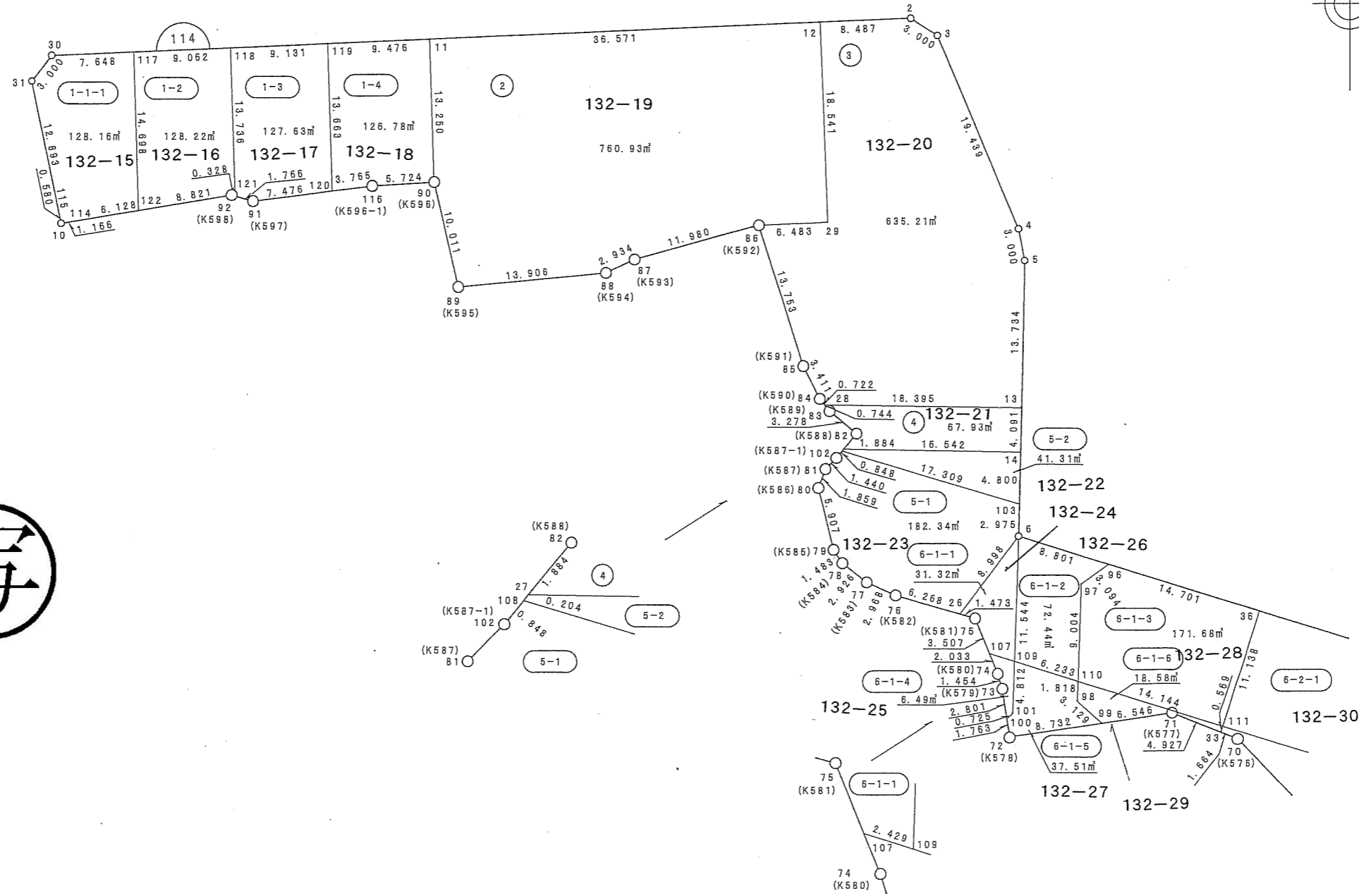
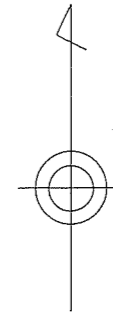

縮尺 1:500

(世界測地系)

蘇我三丁目

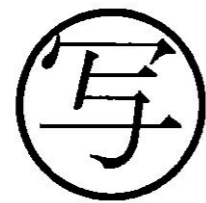
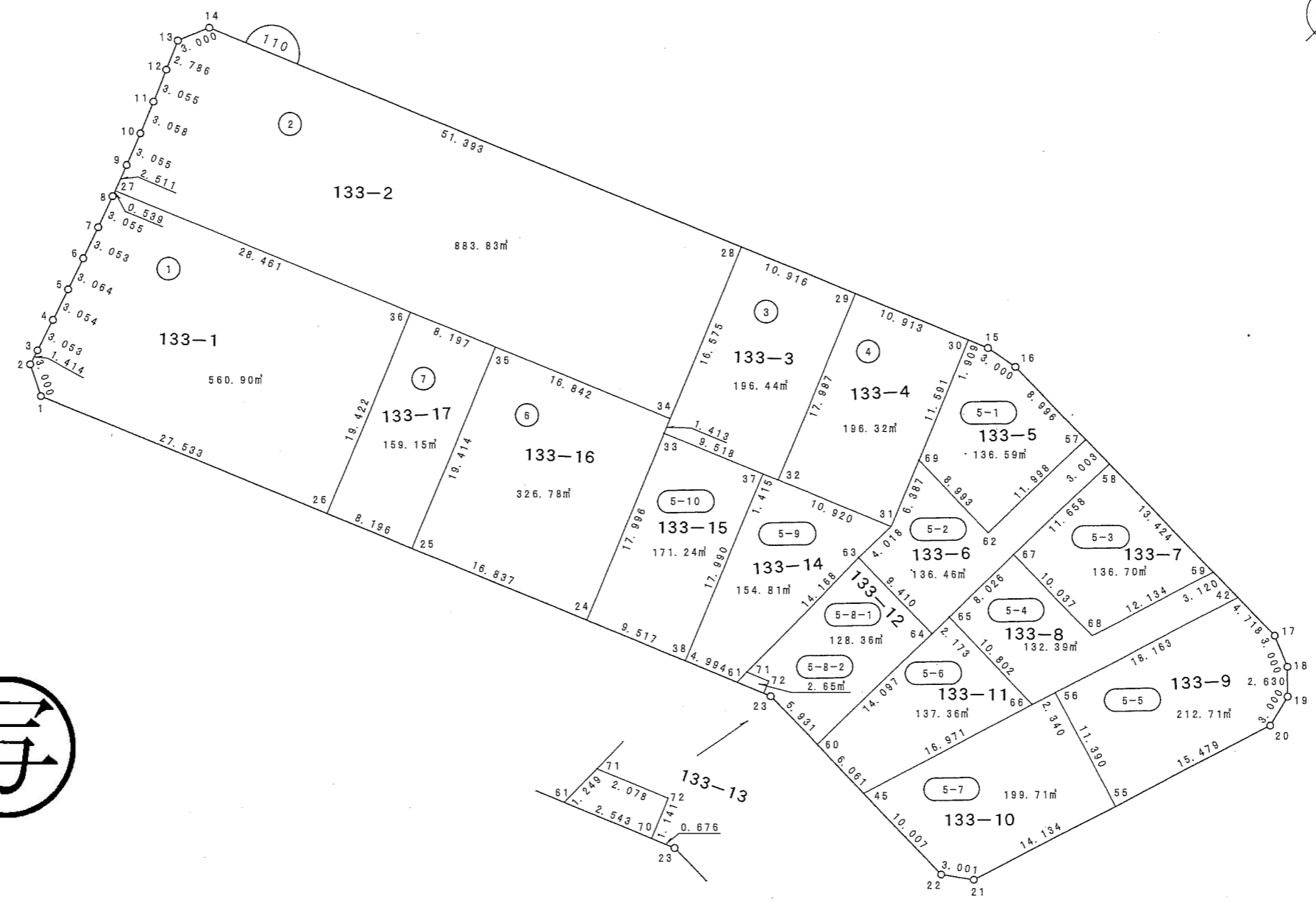
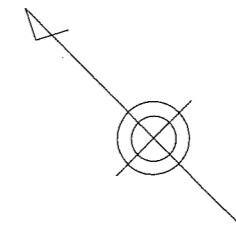

縮尺 1:500

(世界測地系)

蘇我三丁目

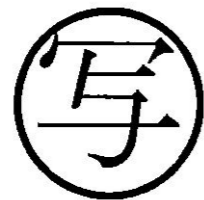
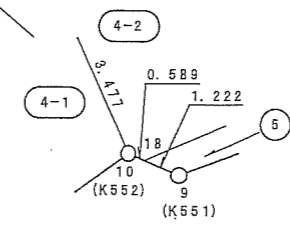
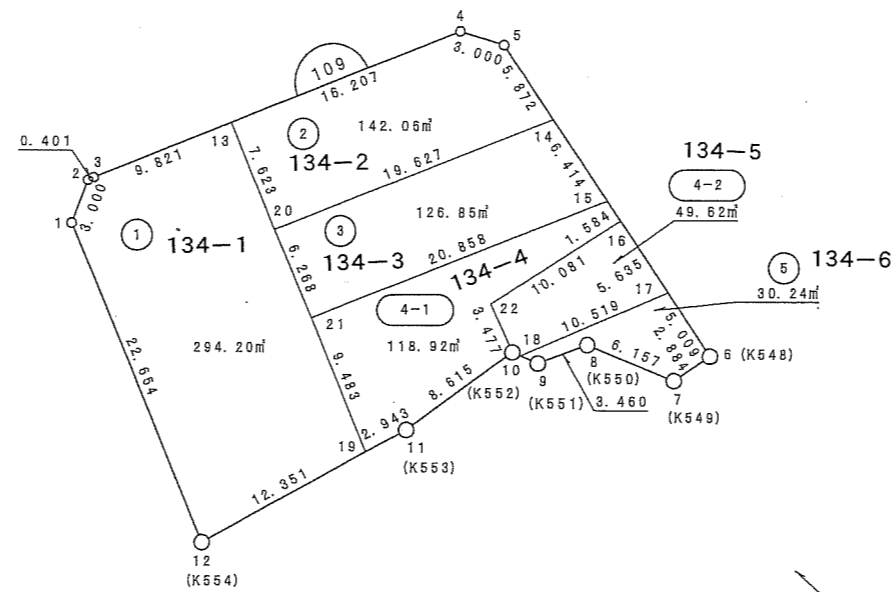
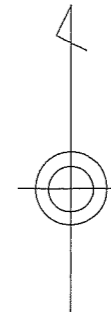

縮尺 1:500

(世界測地系)

蘇我三丁目

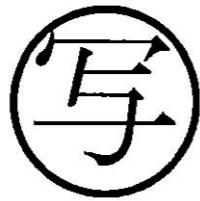
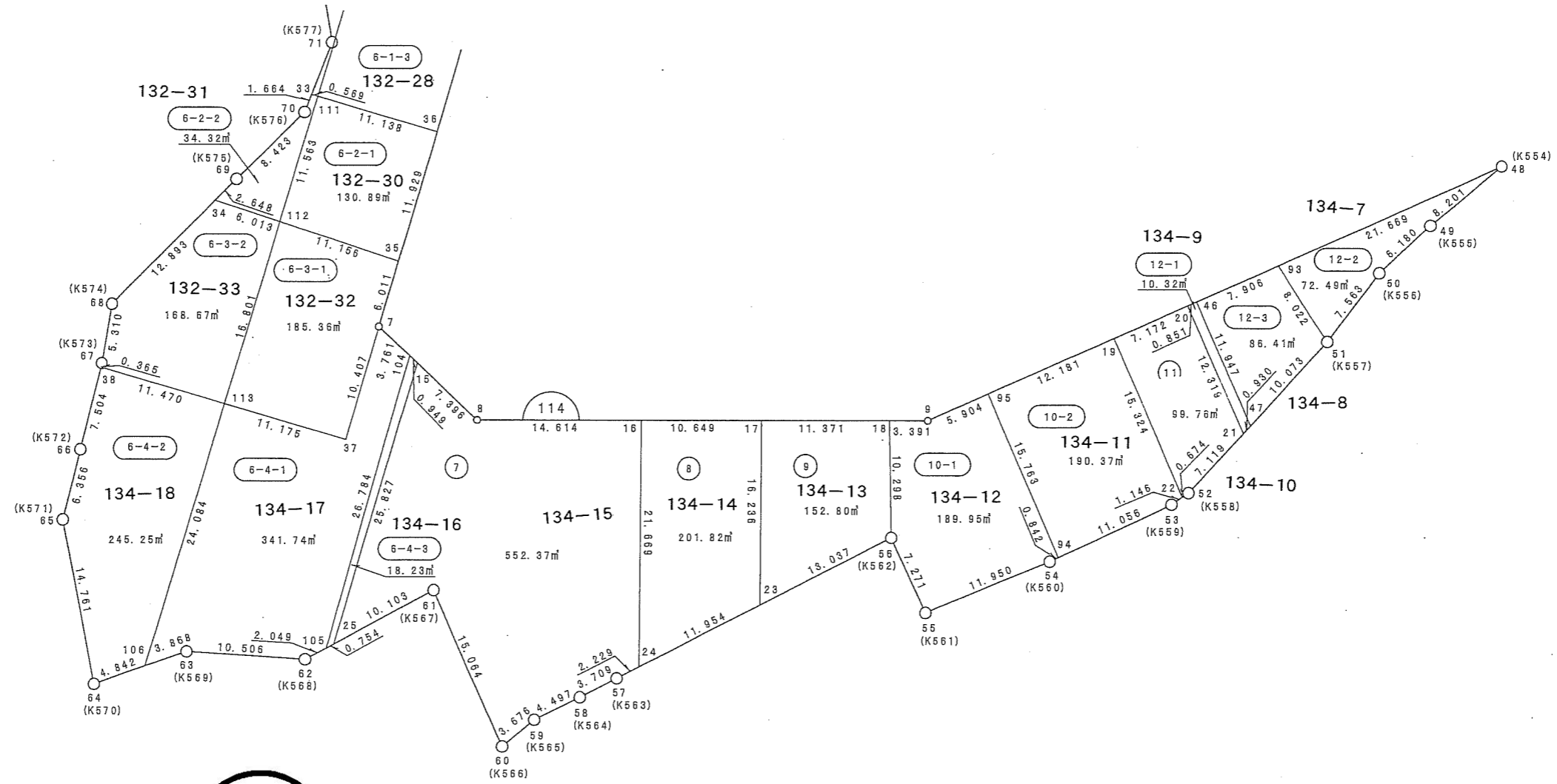
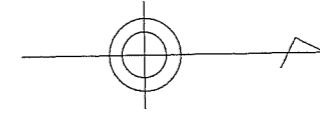

縮尺 1:500

蘇我三丁目

(世界測地系)

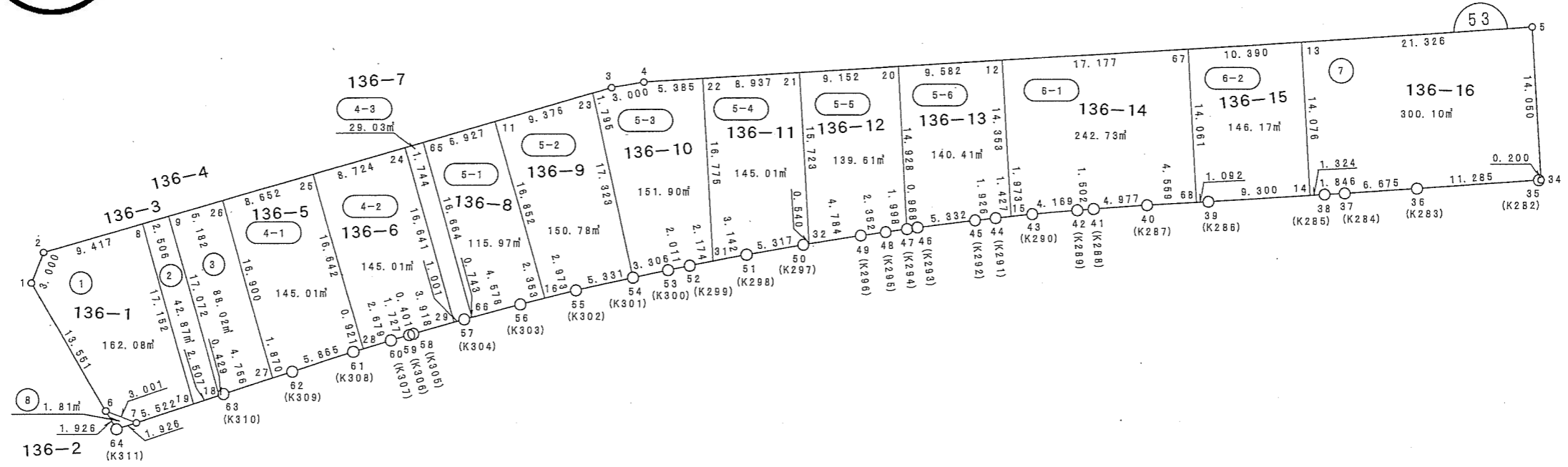
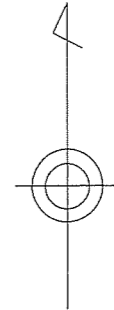
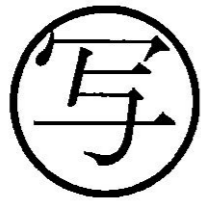

縮尺 1:500

株式会社 日測

蘇我三丁目

(世界測地系)

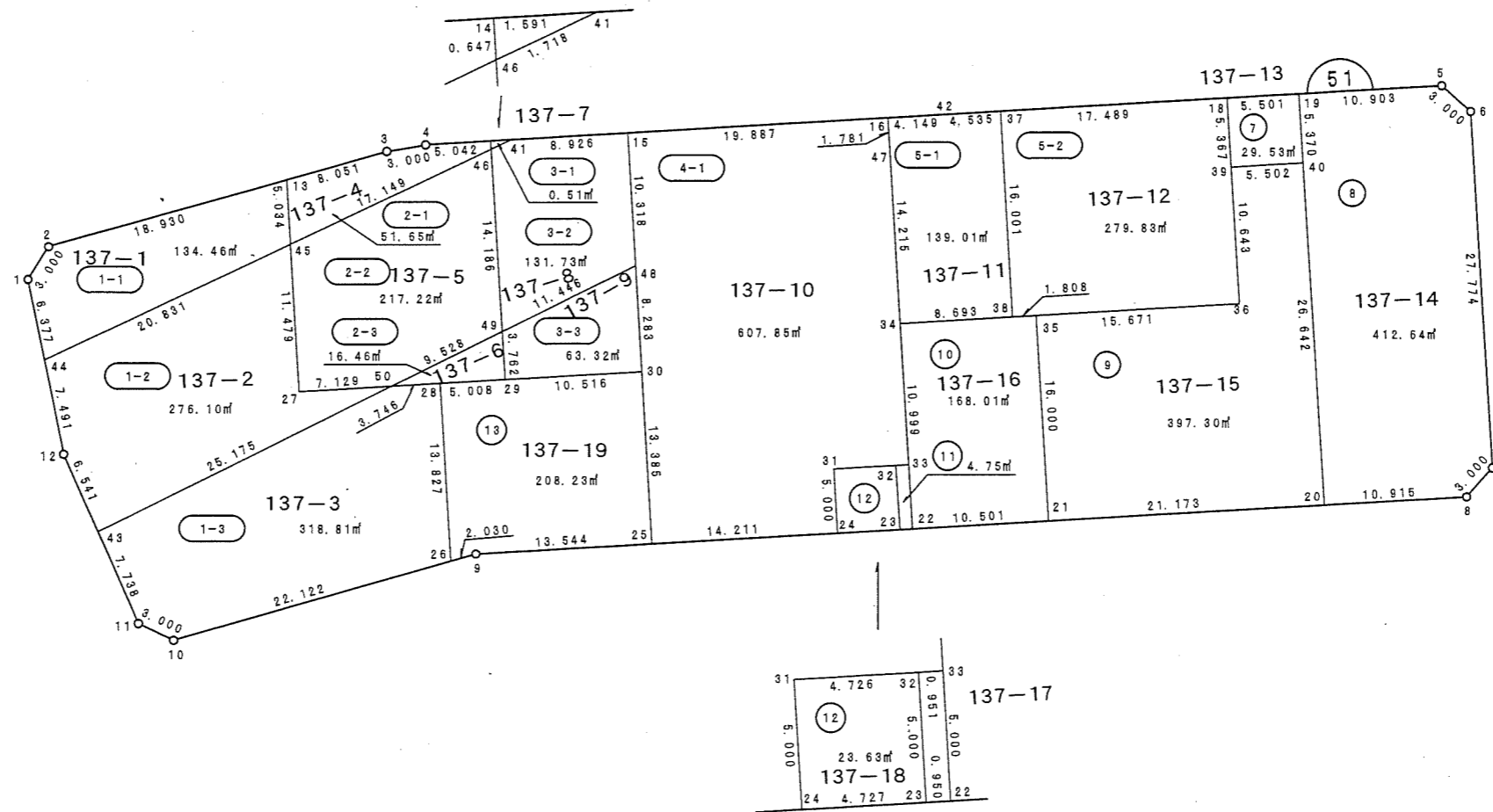
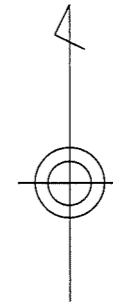

縮尺 1:500

蘇我三丁目

(世界測地系)

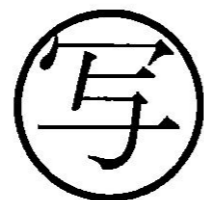
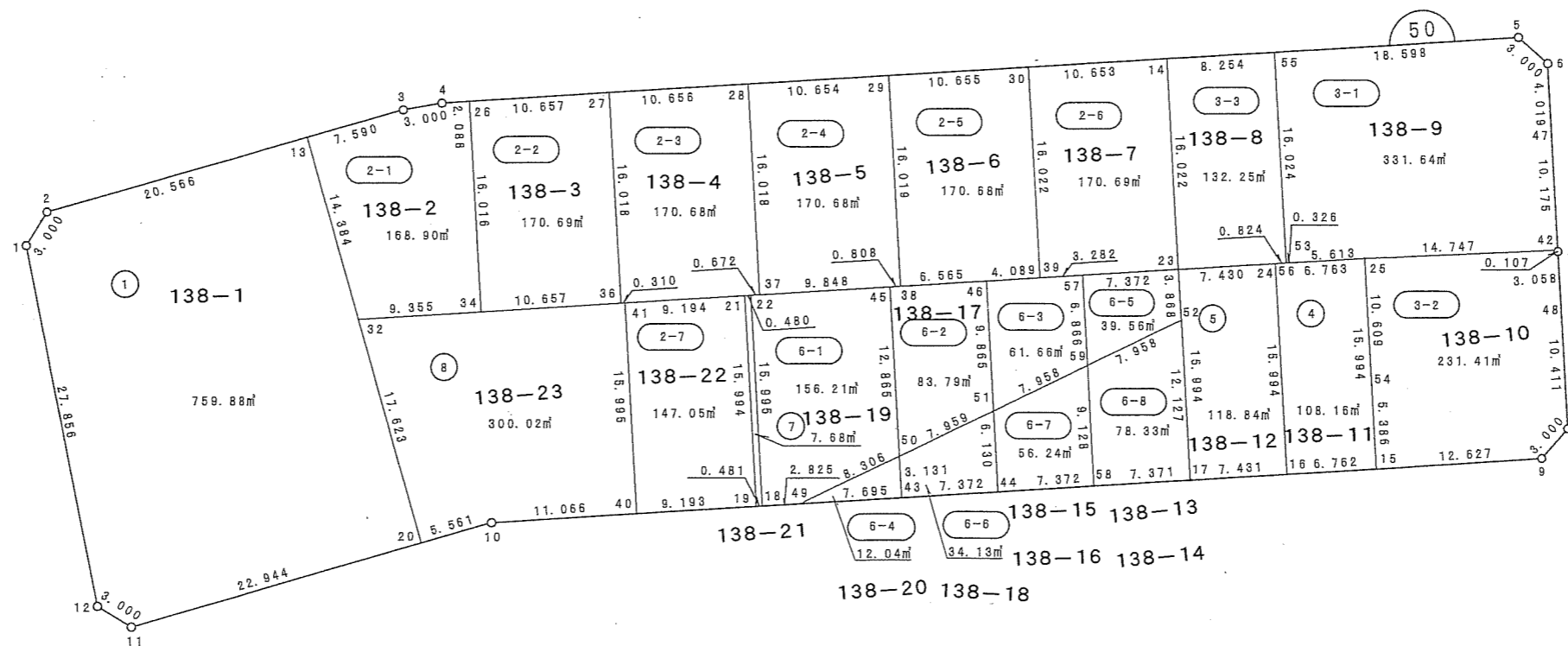
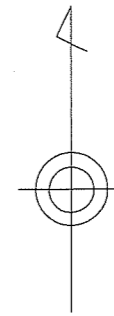

縮尺 1:500

蘇我三丁目

(世界測地系)

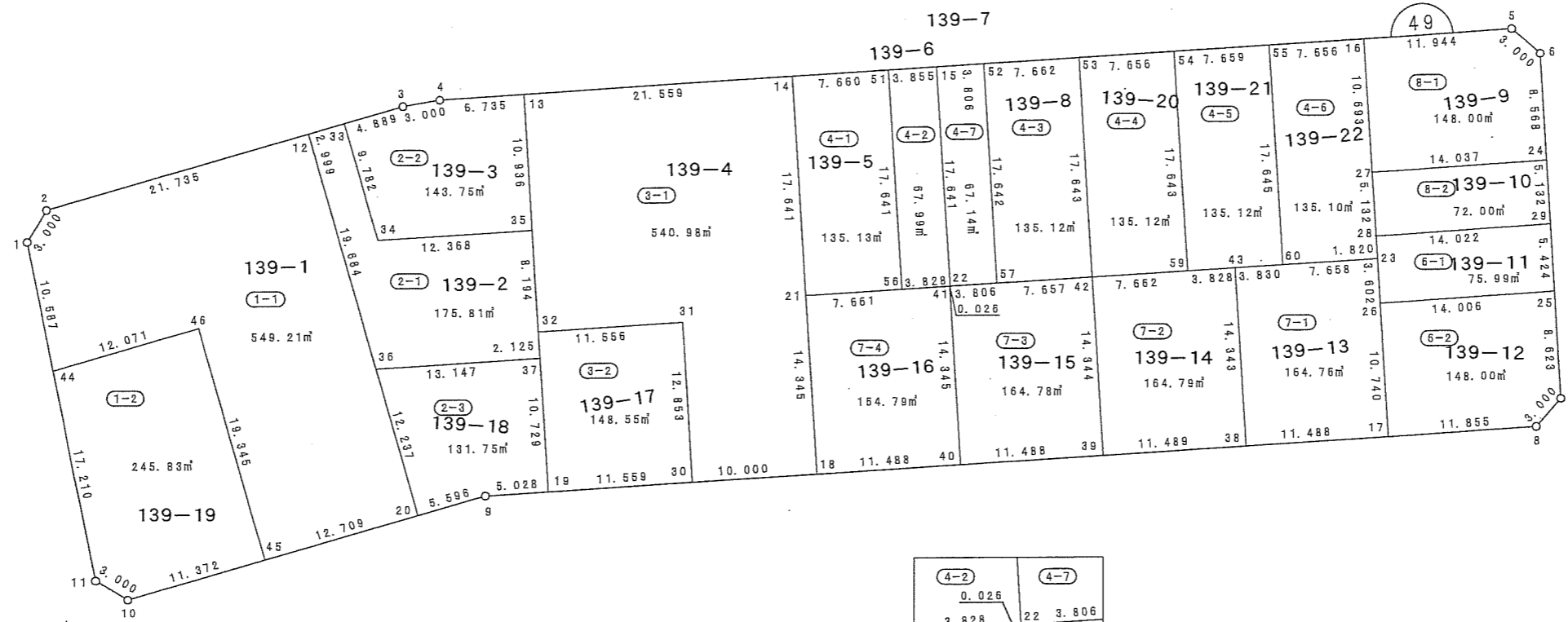
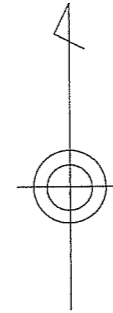

4-2	4-7
0.026	22 3.806
3.828	41
7-4	7-3

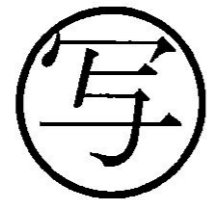

縮尺 1 : 500

蘇我三丁目

(世界測地系)

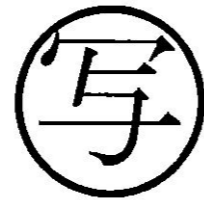
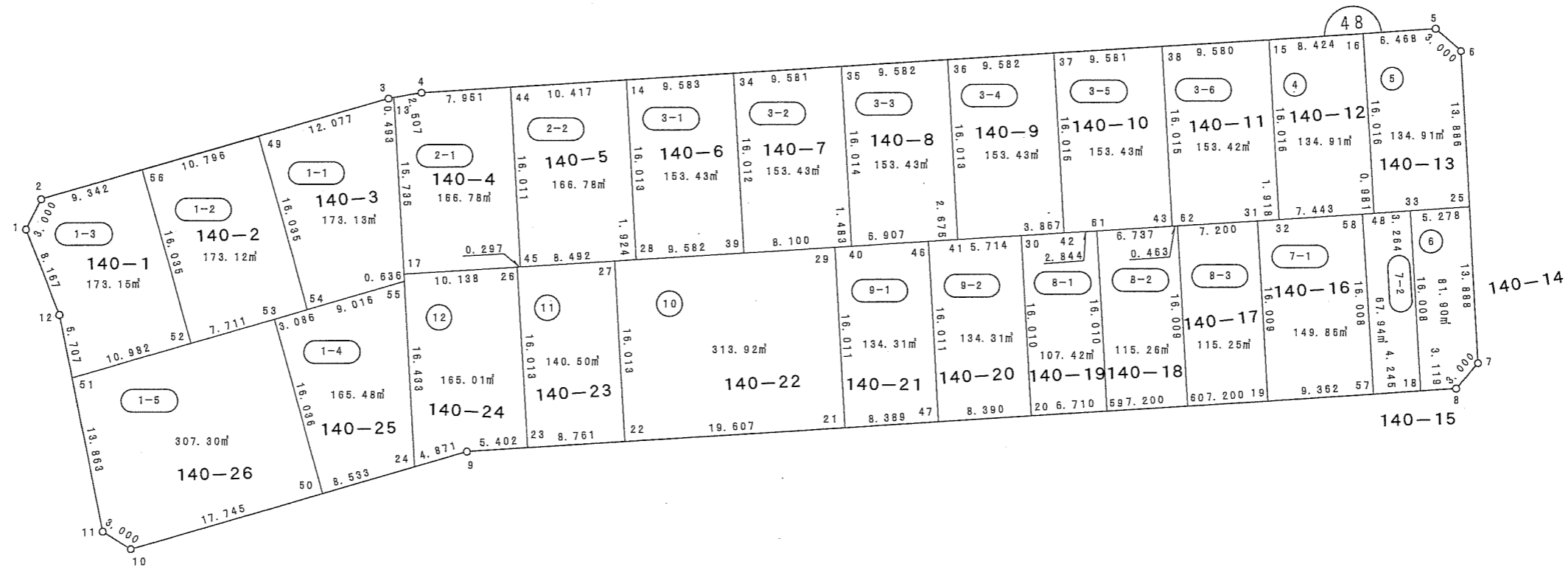
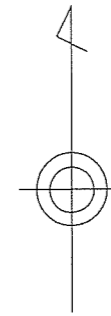

縮尺 1:500

蘇我三丁目

(世界測地系)

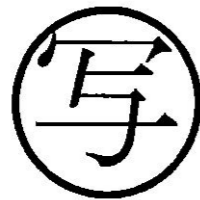
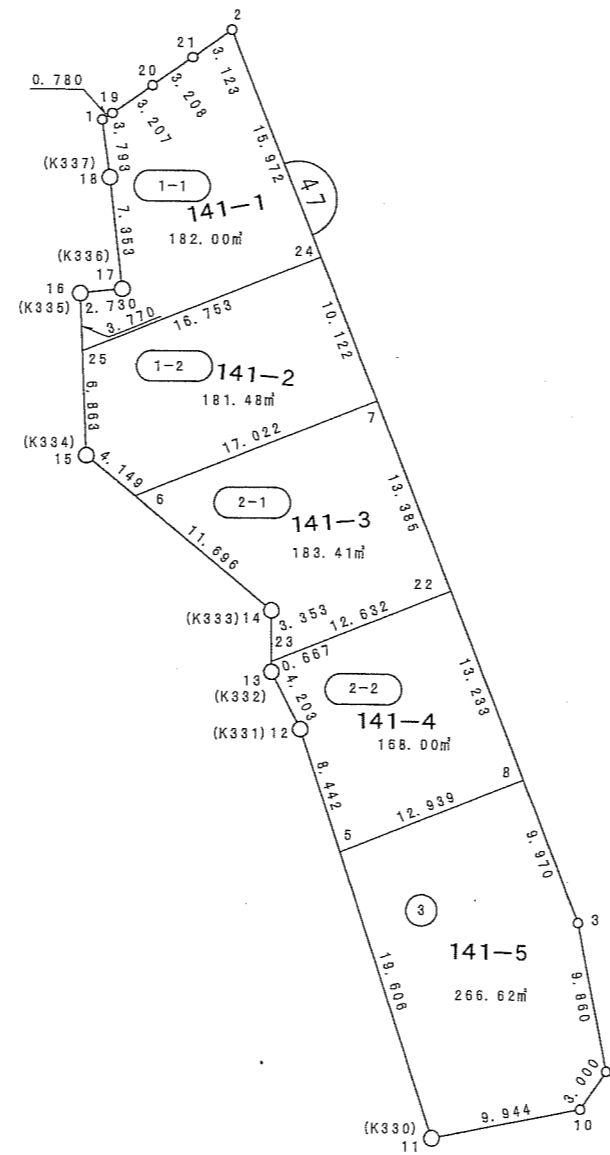
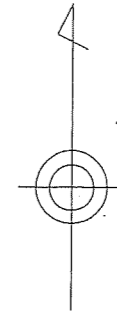

縮尺 1:500

(世界測地系)

蘇我三丁目

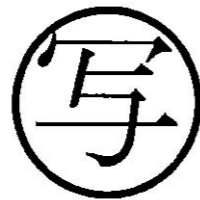
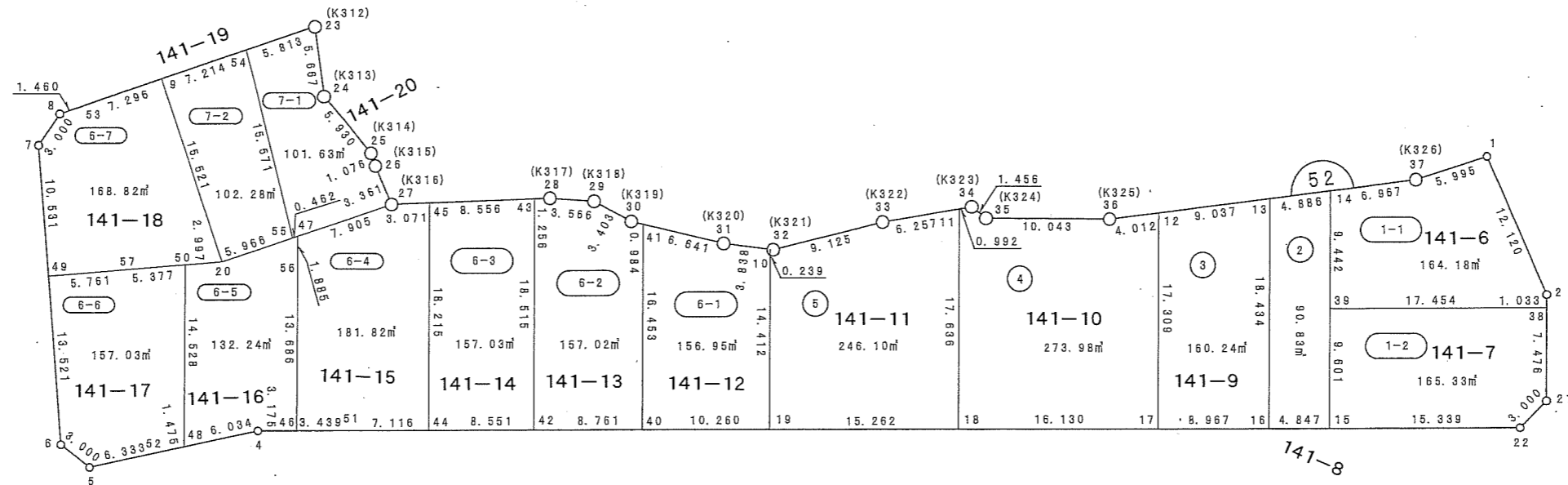
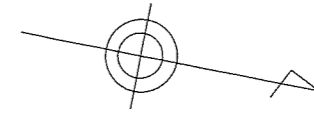

縮尺 1:500

蘇我三丁目

(世界測地系)

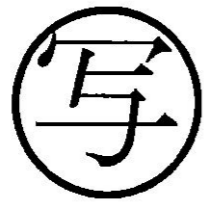
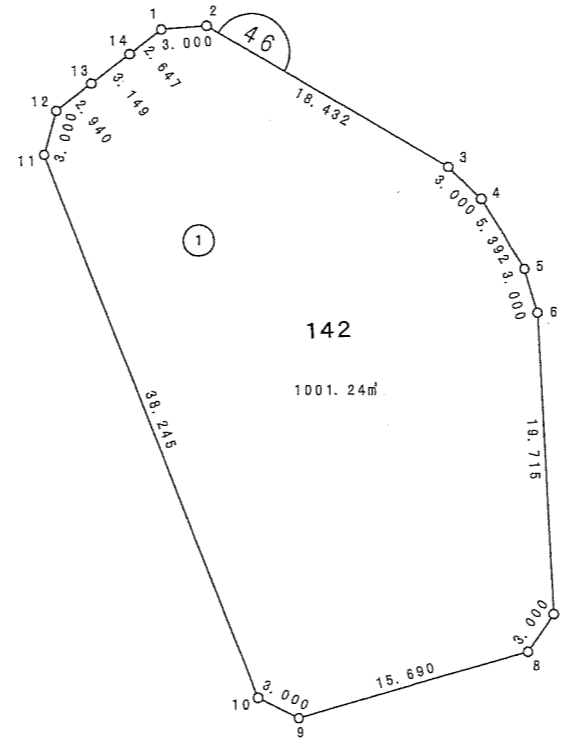
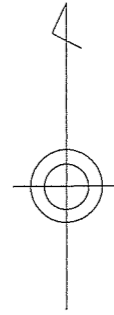

縮尺 1:500

蘇我三丁目

(世界測地系)

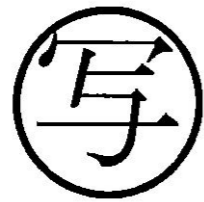
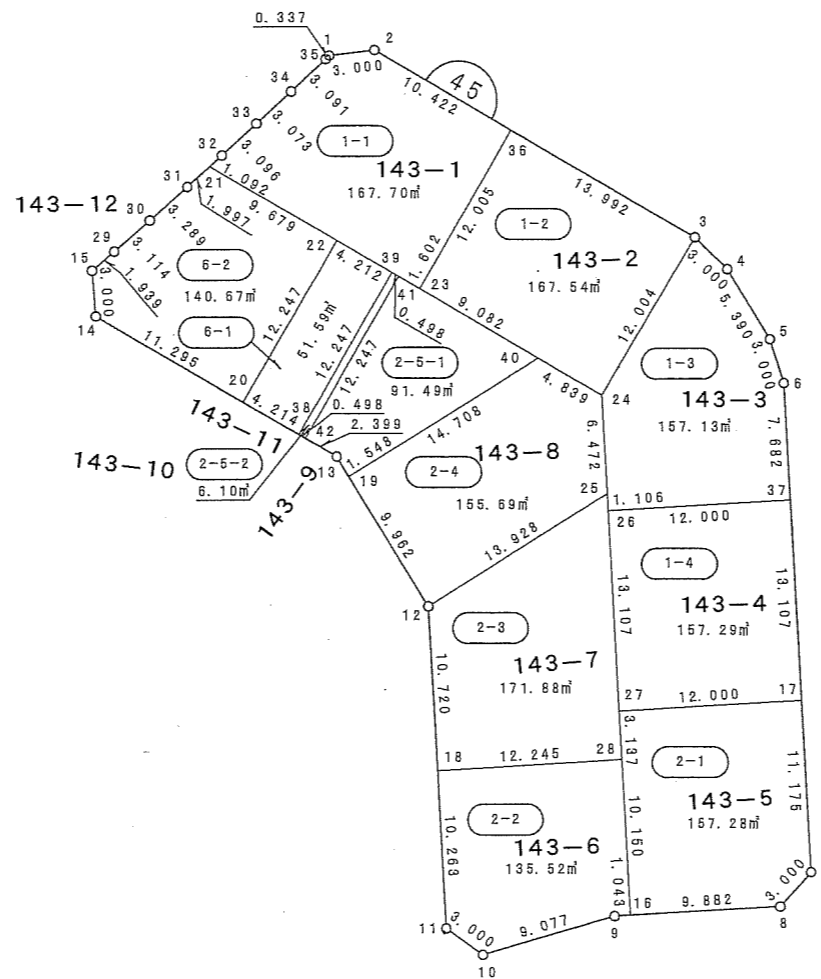
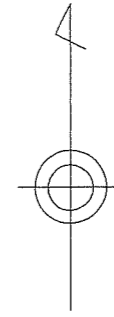

縮尺 1:500

蘇我三丁目

(世界測地系)

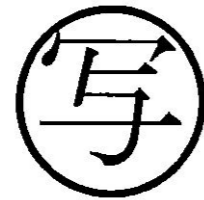
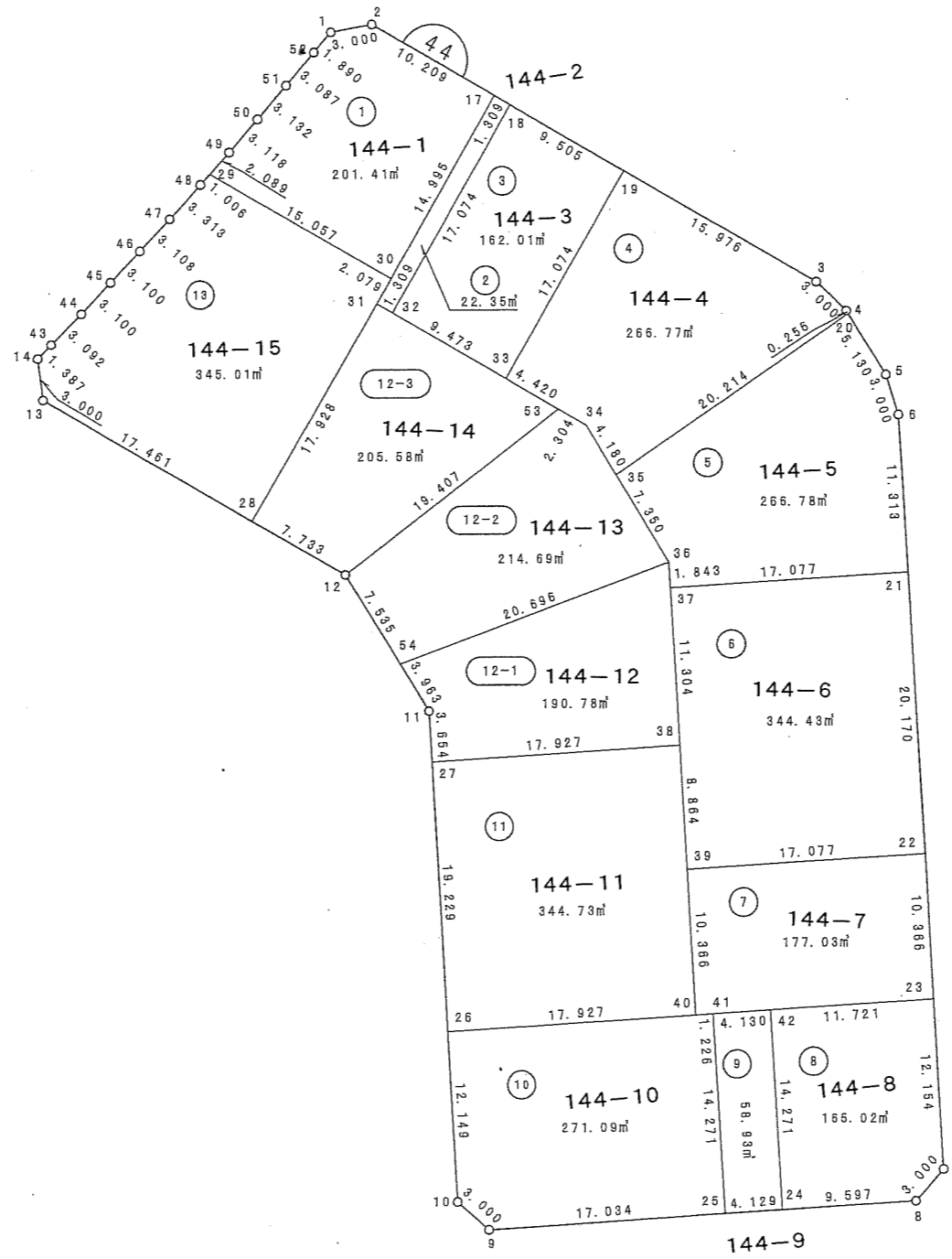
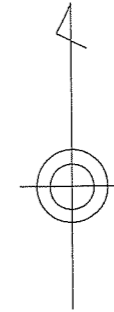

縮尺 1:500

(世界測地系)

蘇我三丁目

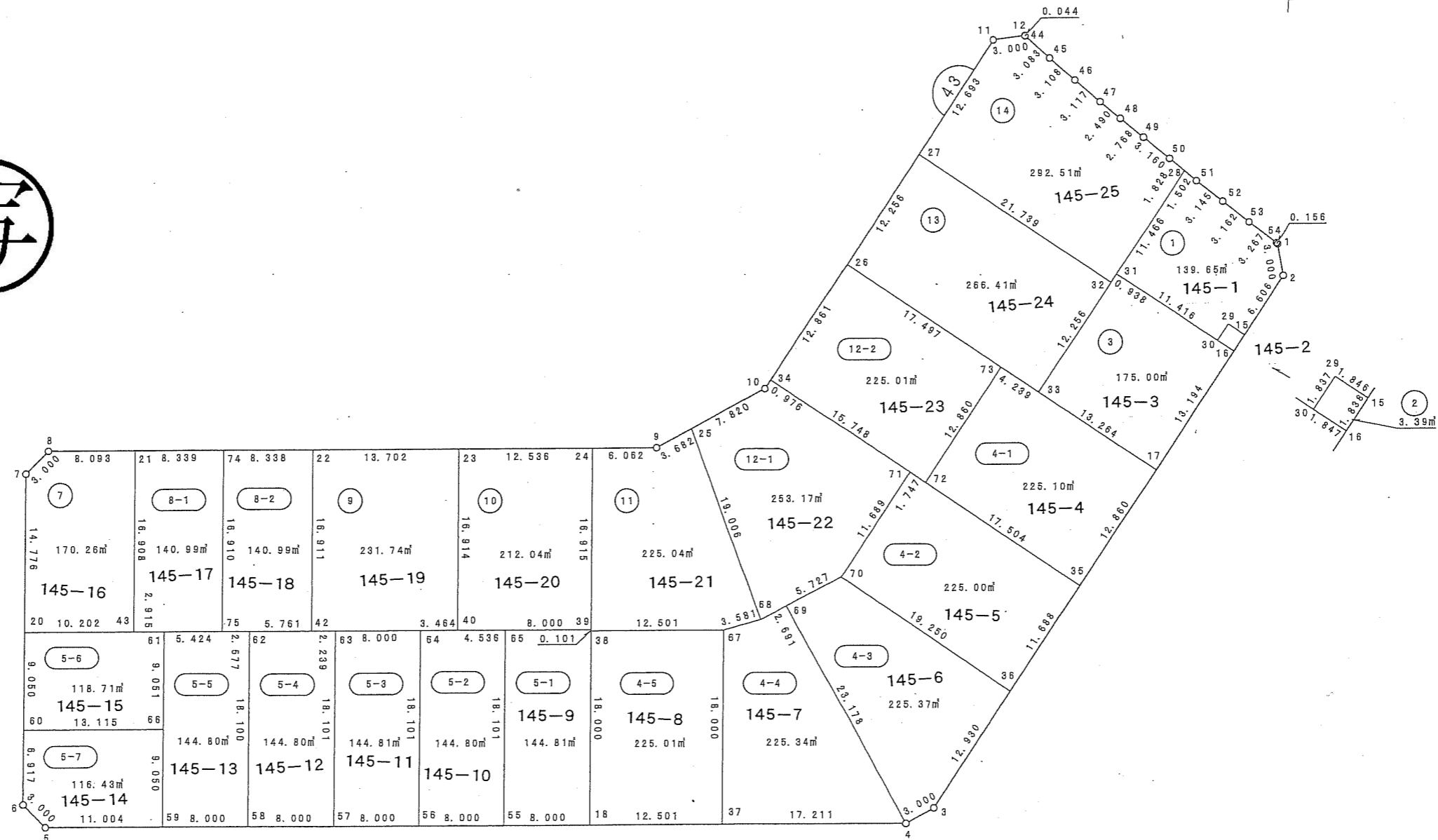
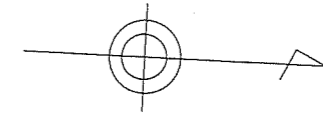
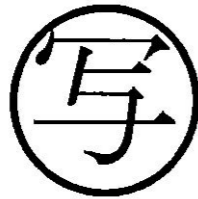

縮尺 1:500

蘇我三丁目

(世界測地系)

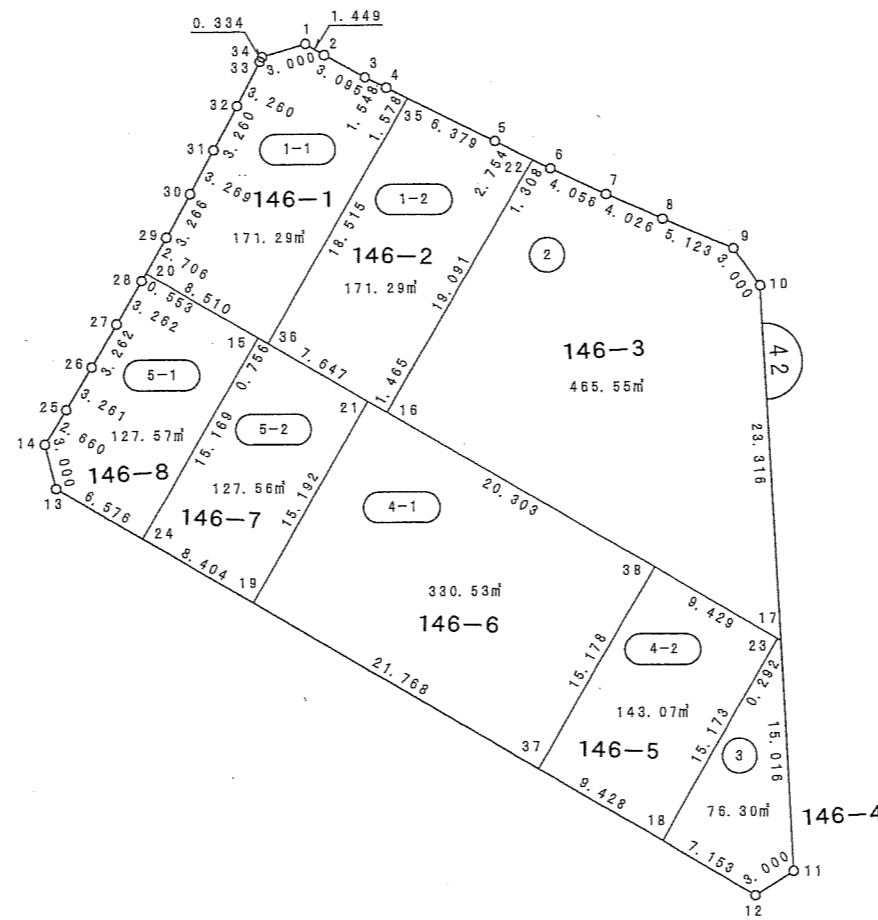
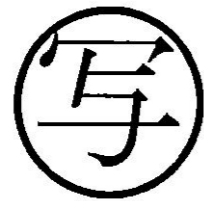
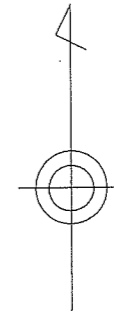

縮尺 1:500

蘇我三丁目

(世界測地系)

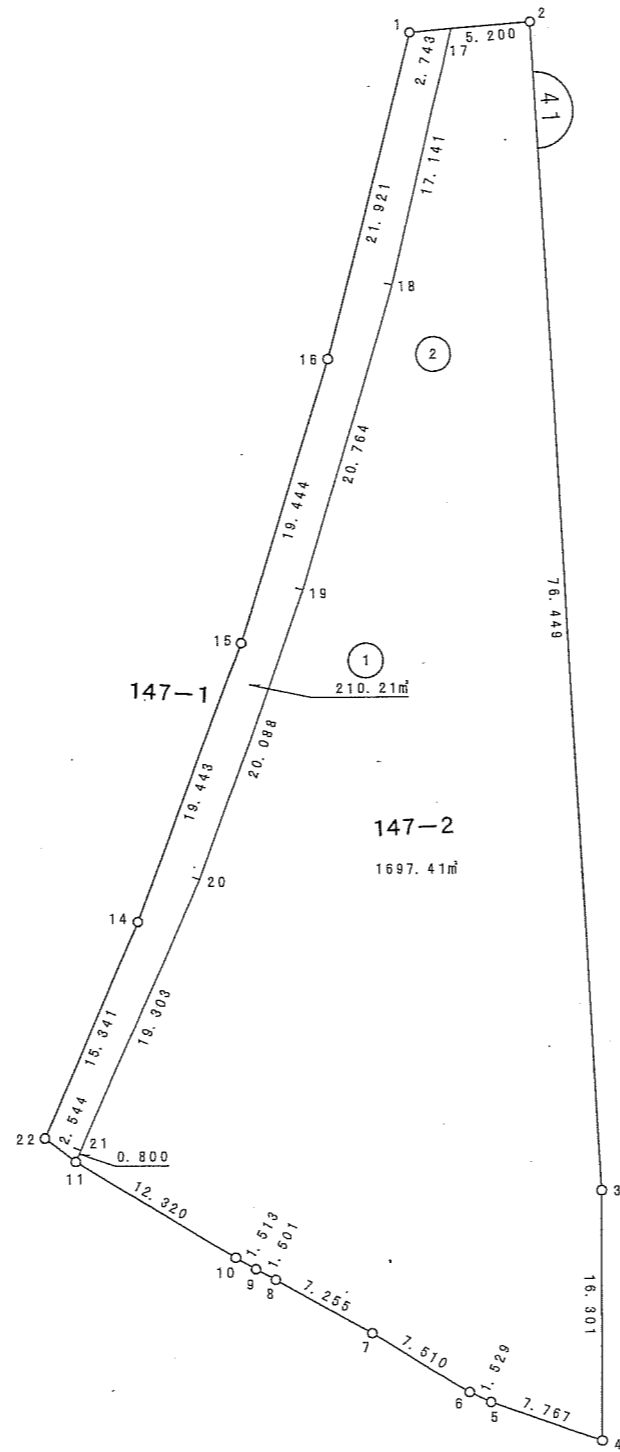
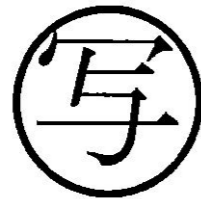
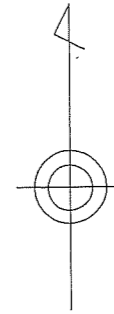

縮尺 1 : 500

蘇我三丁目

(世界測地系)

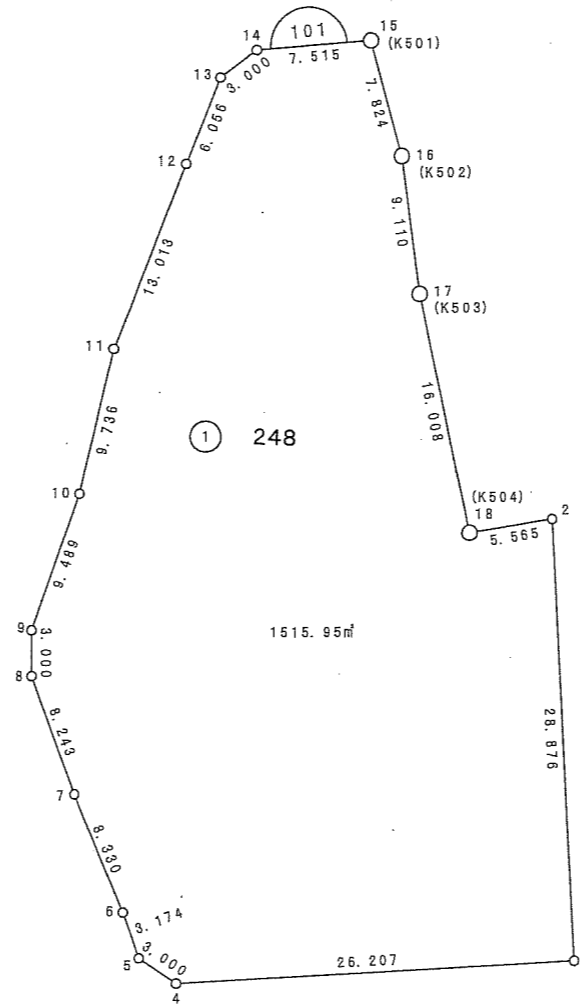
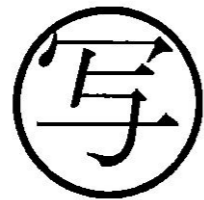
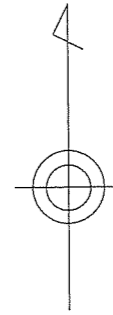

縮尺 1:500